

Luymar

... un uso eficiente del aire

400°C/2h • TRASIEGO

CBXT-Z





BXT-Z VENTILADOR SIMPLE OÍDO A REACCIÓN, MEDIA PRESIÓN, 400°C/2h CON CAJA

- Ventilador simple oído (400°C/2h) con rodete de reacción.
- 14 tamaños diferentes.
- Diseño compacto para proporcionar una alta eficiencia y alta calidad de ejecución.
- Caudales desde 2.500 a más de 100.000 m³/h.

CBXT-Z VENTILADOR SIMPLE OÍDO, MEDIA PRESIÓN, CON CAJA

- Cajas de ventilación 400°C/2h equipadas con ventiladores de rodete de reacción, palas hacia atrás, media-alta presión, simple oído, transmisión por poleas y correas.
- Construidas en chapa de acero galvanizado y aisladas térmica y acústicamente.
- Certificado Applus N° 0370-CPR-3421 (EN12101-3:2016).

BXT-Z SINGLE INLET REACTION, HALF PRESSURE, 400°C / 2h WITH BOX

- Single inlet (400°C / 2h) with reaction impeller.
- 14 different sizes.
- Compact design to provide high efficiency and high quality of operation.
- Flow rates from 2.500 to more than 100.000 m³ / h.

CBXT-Z SINGLE INLET FAN, HALF PRESSURE, WITH BOX

- 400°C/2h ventilation boxes equipped with reaction impeller fans, backward blade, medium-high pressure, single inlet, pulley and belt propulsion.
- Manufactured in galvanized steel sheet and insulated thermally and acoustically.
- Certificate Applus N° 0370-CPR-3421 (EN12101-3:2016).

BXT-Z VENTILATEUR SIMPLE OUÏE, DEMI-PRESSION, 400°C/2h AVEC BOITE

- Ventilateur mono-ouïe (400°C/2h) avec turbine à réaction.
- 14 tailles différentes.
- Conception compacte pour fournir une grande efficacité et une haute qualité d'exécution.
- Débit de 2.500 à plus de 100.000 m³/h.

CBXT-Z VENTILATEUR SIMPLE OUÏE, DEMI-PRESSION, AVEC BOÎTE

- Caissons de ventilation 400°C/2h équipés de ventilateurs avec roue à réaction, pelles en arrière, moyenne-haute pression, simple ouïe, transmission par poulies et courroies.
- Construit en tôle d'acier galvanisé et isolé thermiquement et acoustiquement.
- Certificat Applus N° 0370-CPR-3421 (EN12101-3:2016).

MODELO	Velocidad (r/min.)	Potencia (kW)	Caudal (m ³ /h)	I. máx. (A)			Peso (kg)	Presión Acústica (dB(A))	BXT-Z	CBXT-Z
				230V	400V	690V			Código	Código
315 - 0,75 cv	2520	0,55	4000	2,74	1,58		3	84	0346031503	0346231503
315 - 1 cv	2800	0,75	4500	3,0	1,8		35	84	0346031504	0346231504
315 - 1,5 cv	3250	1,1	5050	4,3	2,5		40	87	0346031505	0346231505
315 - 2 cv	3550	1,5	5650	5,7	3,3		45	91	0346031506	0346231506
315 - 3 cv	3700	2,2	6400	7,8	4,5		53	91	0346031507	0346231507
355 - 0,75 cv	2100	0,55	4750	2,74	1,58		45	82	0346035503	0346235503
355 - 1 cv	2300	0,75	5200	3,0	1,8		47	85	0346035504	0346235504
355 - 1,5 cv	2600	1,1	6000	4,3	2,5		51	87	0346035505	0346235505
355 - 2 cv	2875	1,5	6650	5,7	3,3		56	89	0346035506	0346235506
355 - 3 cv	3350	2,2	7500	7,8	4,5		65	91	0346035507	0346235507
355 - 4 cv	3400	3	8200	10,4	6,0		70	95	0346035508	0346235508
400 - 1 cv	1900	0,75	6100	3,0	1,8		56	84	0346040004	0346240004
400 - 1,5 cv	2180	1,1	7000	4,3	2,5		60	86	0346040005	0346240005
400 - 2 cv	2400	1,5	7700	5,7	3,3		65	87	0346040006	0346240006
400 - 3 cv	2750	2,2	8800	7,8	4,5		74	90	0346040007	0346240007
400 - 4 cv	3050	3	9800	10,4	6,0		79	95	0346040008	0346240008
400 - 5,5 cv	3300	4	10500	13,8	8,0		96	96	0346040009	0346240009
450 - 1 cv	1380	0,75	6500	3,0	1,8		83	81	0346040004	0346240004
450 - 1,5 cv	1550	1,1	7500	4,3	2,5		87	85	0346040005	0346240005
450 - 2 cv	1700	1,5	8050	5,7	3,3		92	87	0346040006	0346240006
450 - 3 cv	1950	2,2	9050	7,8	4,5		101	88	0346040007	0346240007
450 - 4 cv	2200	3	10100	10,4	6,0		106	93	0346040008	0346240008
450 - 5,5 cv	2400	4	11500	13,8	8,0		123	95	0346040009	0346240009
450 - 7,5 cv	2600	5,5	12500		10,7	6,2	132	98	0346040010	0346240010
500 - 1,5 cv	1250	1,1	8200	4,3	2,5		96	83	0346050005	0346250005
500 - 2 cv	1380	1,5	9000	5,7	3,3		101	86	0346050006	0346250006
500 - 3 cv	1560	2,2	10200	7,8	4,5		110	88	0346050007	0346250007
500 - 4 cv	1730	3	11500	10,4	6,0		115	91	0346050008	0346250008
500 - 5,5 cv	1900	4	12500	13,8	8,0		132	93	0346050009	0346250009
500 - 7,5 cv	2130	5,5	14000		10,7	6,2	141	96	0346050010	0346250010
500 - 10 cv	2300	7,5	15500	5,7	14,3	8,3	156	98	0346050011	0346250011
560 - 2 cv	1200	1,5	11000	7,8	3,3		134	85	0346056006	0346256006
560 - 3 cv	1380	2,2	12200	10,4	4,5		143	88	0346056007	0346256007
560 - 4 cv	1500	3	14000	13,8	6,0		148	90	0346056008	0346256008
560 - 5,5 cv	1670	4	15500		8,0		165	93	0346056009	0346256009
560 - 7,5 cv	1850	5,5	16200		10,7	6,2	174	95	0346056010	0346256010
560 - 10 cv	1900	7,5	18300		14,3	8,3	189	98	0346056011	0346256011
560 - 15 cv	2000	11	21000	7,8	20,4	11,8	200	99	0346056013	0346256013
630 - 3 cv	1060	2,2	13200	10,4	4,5		166	87	0346063007	0346263007
630 - 4 cv	1150	3	14400	13,8	6,0		171	89	0346063008	0346263008
630 - 5,5 cv	1300	4	16000		8,0		188	91	0346063009	0346263009
630 - 7,5 cv	1450	5,5	18000		10,7	6,2	197	94	0346063010	0346263010
630 - 10 cv	1600	7,5	19800		14,3	8,3	212	96	0346063011	0346263011
630 - 15 cv	1700	11	23040	10,4	20,4	11,8	224	97	0346063013	0346263013
710 - 5,5 cv	1100	4	19080		8,0		258	90	0346071009	0346271009

Montaje vertical +10%.

* Motor IE3

CBXT-Z

400°C/2h • TRASIEGO

MODELO	Velocidad (r/min.)	Potencia (kW)	Caudal (m³/h)	I. máx. (A)			Peso (kg)	Presión Acústica (dB(A))	BXT-Z	CBXT-Z
				230V	400V	690V			Código	Código
710 - 7,5 cv	1200	5,5	20880		10,7	6,2	267	93	0346071010	0346271010
710 - 10 cv	1350	7,5	23760		14,3	8,3	282	94	0346071011	0346271011
710 - 15 cv	1550	11	27720		20,4	11,8	294	98	0346071013	0346271013
710 - 20 cv	1600	15	29880		17,3	15,8	315	100	0346071014	0346271014
710 - 25 cv	1650	18,5	32100	13,8	33,5	19,3	369	101	0346071015	0346271015
800 - 5,5 cv	800	4	22680		8,0		298	88	0346080009	346280009
800 - 7,5 cv	970	5,5	25100		10,7	6,2	307	91	0346080010	0346280010
800 - 10 cv	1070	7,5	27720		14,3	8,3	322	93	0346080011	0346280011
800 - 15 cv	1230	11	32040		20,4	11,8	334	96	0346080013	0346280013
800 - 20 cv	1350	15	34000		17,3	15,8	355	98	0346080014	0346280014
800 - 25 cv	1450	18,5	37800	13,8	33,5	19,3	409	101	0346080015	0346280015
900 - 5,5 cv	720	4	26000		8,0		378	87	0346090009	0346290009
900 - 7,5 cv	790	5,5	29500		10,7	6,2	387	90	0346090010	0346290010
900 - 10 cv	860	7,5	32100		14,3	8,3	402	93	0346090011	0346290011
900 - 15 cv	1020	11	37900		20,4	11,8	414	97	0346090013	0346290013
900 - 20 cv	1120	15	42000		17,3	15,8	435	98	0346090014	0346290014
900 - 25 cv	1190	18,5	43500		33,5	19,3	489	100	0346090015	0346290015
1000 - 7,5 cv	660	5,5	33000		10,7	6,2	447	89	0346100010	0346300010
1000 - 10 cv	730	7,5	37000		14,3	8,3	462	92	0346100011	0346300011
1000 - 15 cv	840	11	42500		20,4	11,8	474	95	0346100013	0346300013
1000 - 20 cv	940	15	46000		17,3	15,8	495	97	0346100014	0346300014
1000 - 25 cv	1000	18,5	50000		33,5	19,3	549	99	0346100015	0346300015
1000 - 30 cv	1060	22	52500		39,7	22,9	593	101	0346100016	0346300016

Montaje vertical +10%.

* Motor IE3



DIMENSIONES

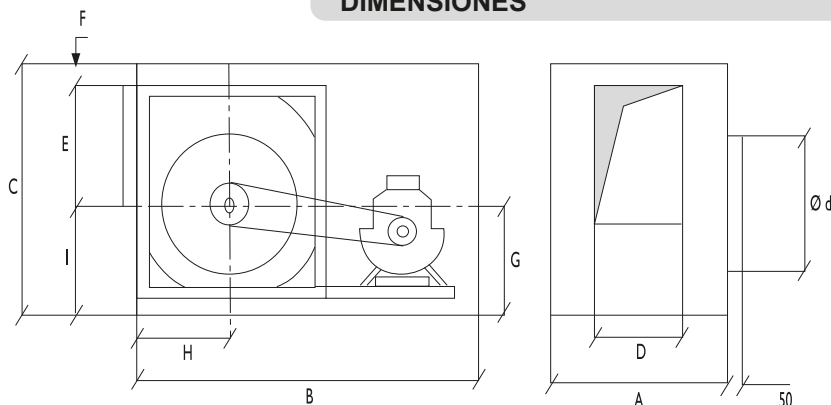

MODELO	MEDIDAS DE LAS CAJAS EN mm.									IMPULSIÓN VERTICAL		
	A	B	C	D	E	G	H	F	Ød	C ₁	B ₁	F ₁
225	500	700	522	175	272	240	225	68	225			
250	516	750	575	190	297	251	265	79	250			
280	540	850	650	225	360	290	304	65	280			
315	540	850	650	275	415	325	335	84	315			
355	600	1000	755	275	415	325	335	84	355			
400	620	1200	875	308	487	382	360	78	400			
450	620	1272	967	322	611	477	430	177	450	1080	1380	40
500	730	1300	1175	355	699	515	450	165	500	1146	1510	40
560	763	1403	1250	355	699	515	450	165	560	1146	1510	40
630	823	1503	1380	414	799	573	460	170	630	1226	1655	40
710	857	1653	1600	471	939	702	570	121	710	1431	1875	40

ORIENTACIONES

Orientación (Vista lado transmisión)
Orientation (View transmission side)

1
Sentido horario
(Rotación a la derecha)
Clockwise
(Right hand)
RD / OR.1

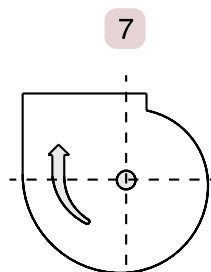
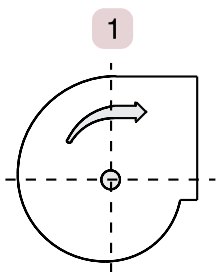

9
Sentido anti horario
(Rotación a izquierda)
Counter clockwise
(Left hand)
LG / OR.9

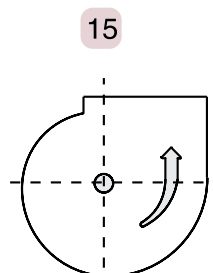
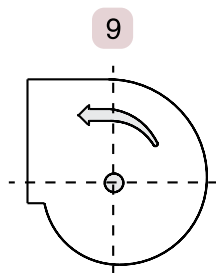



315

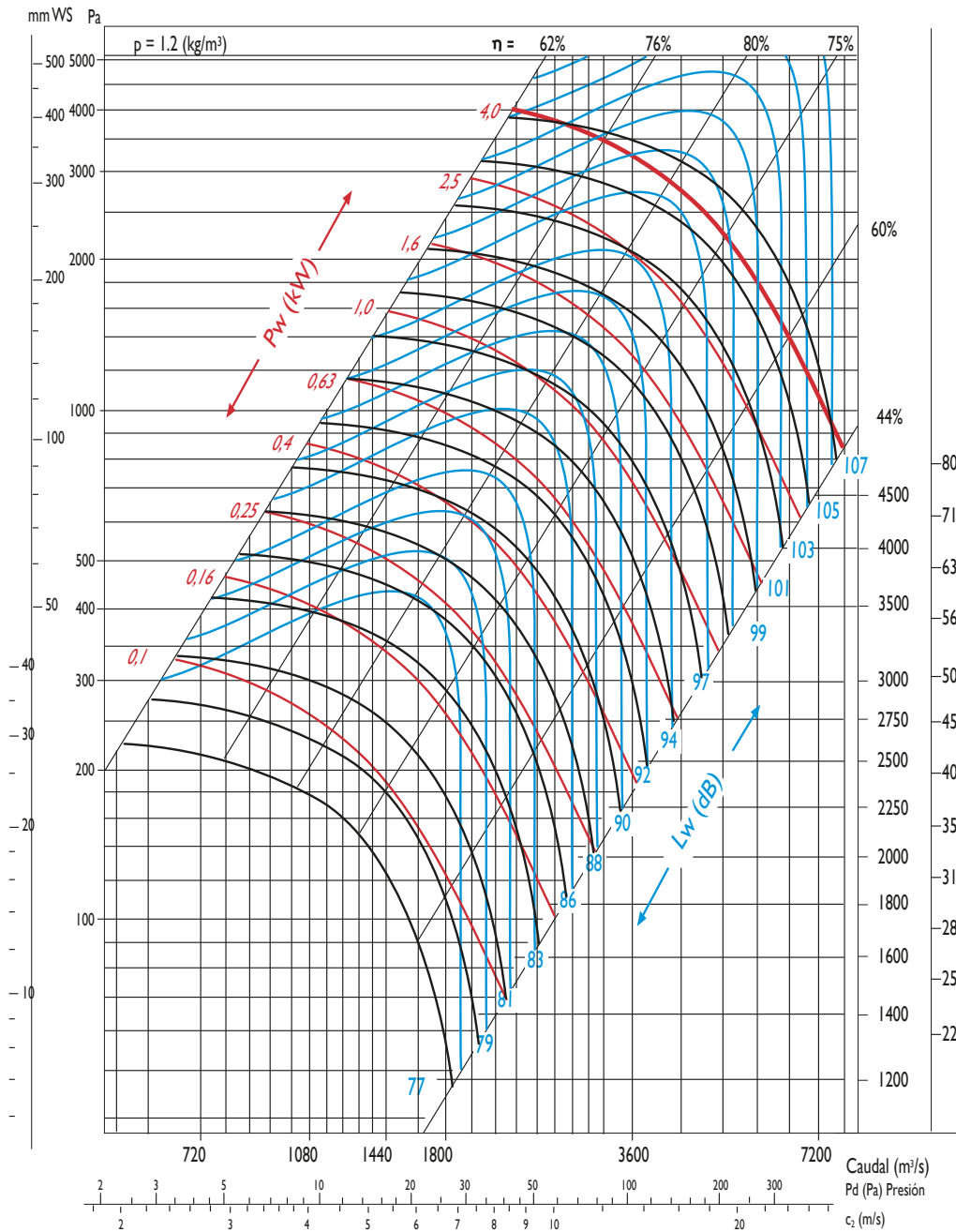

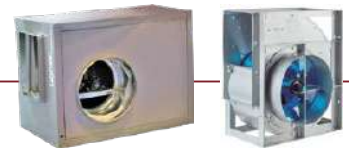

355

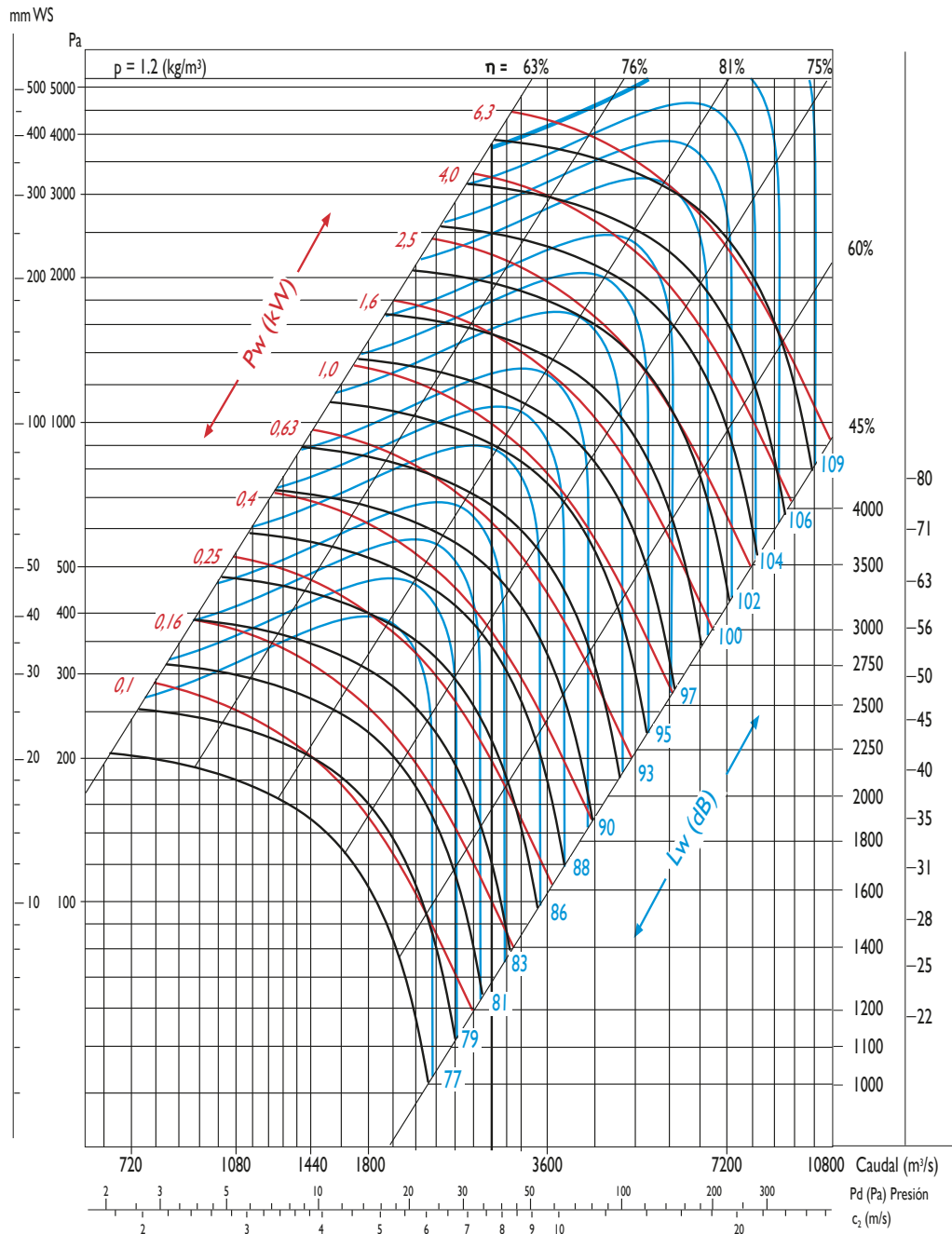



400

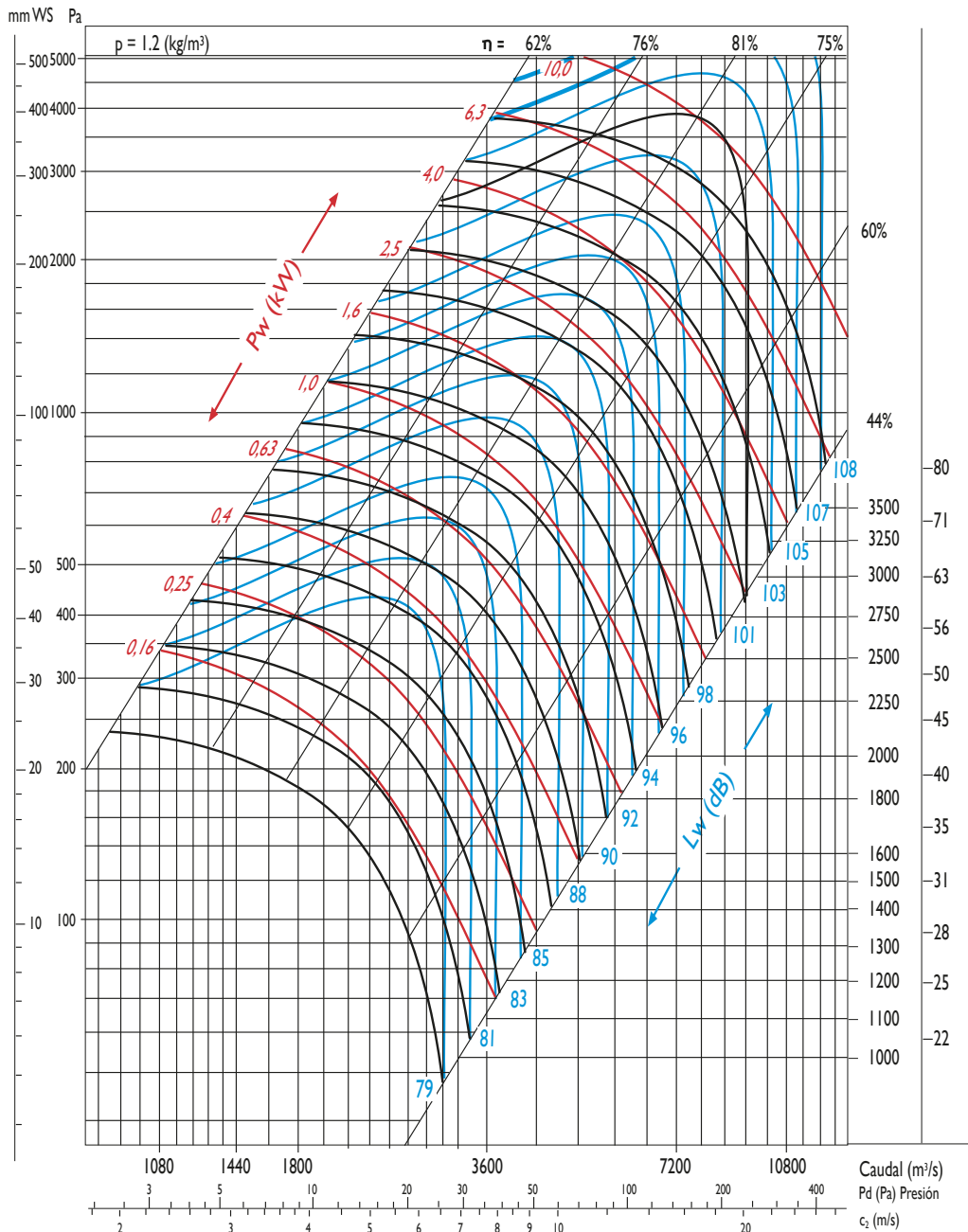



450

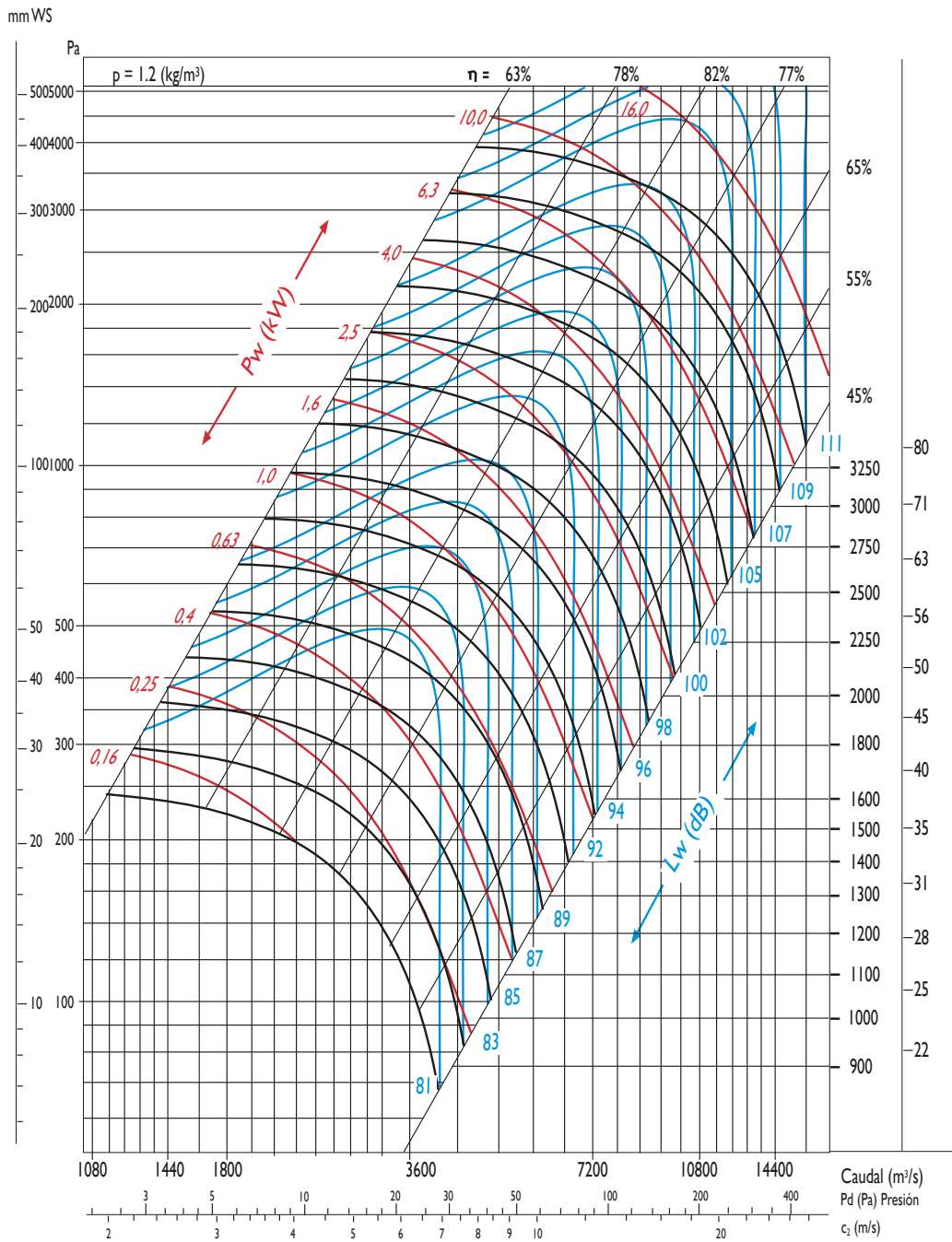



500

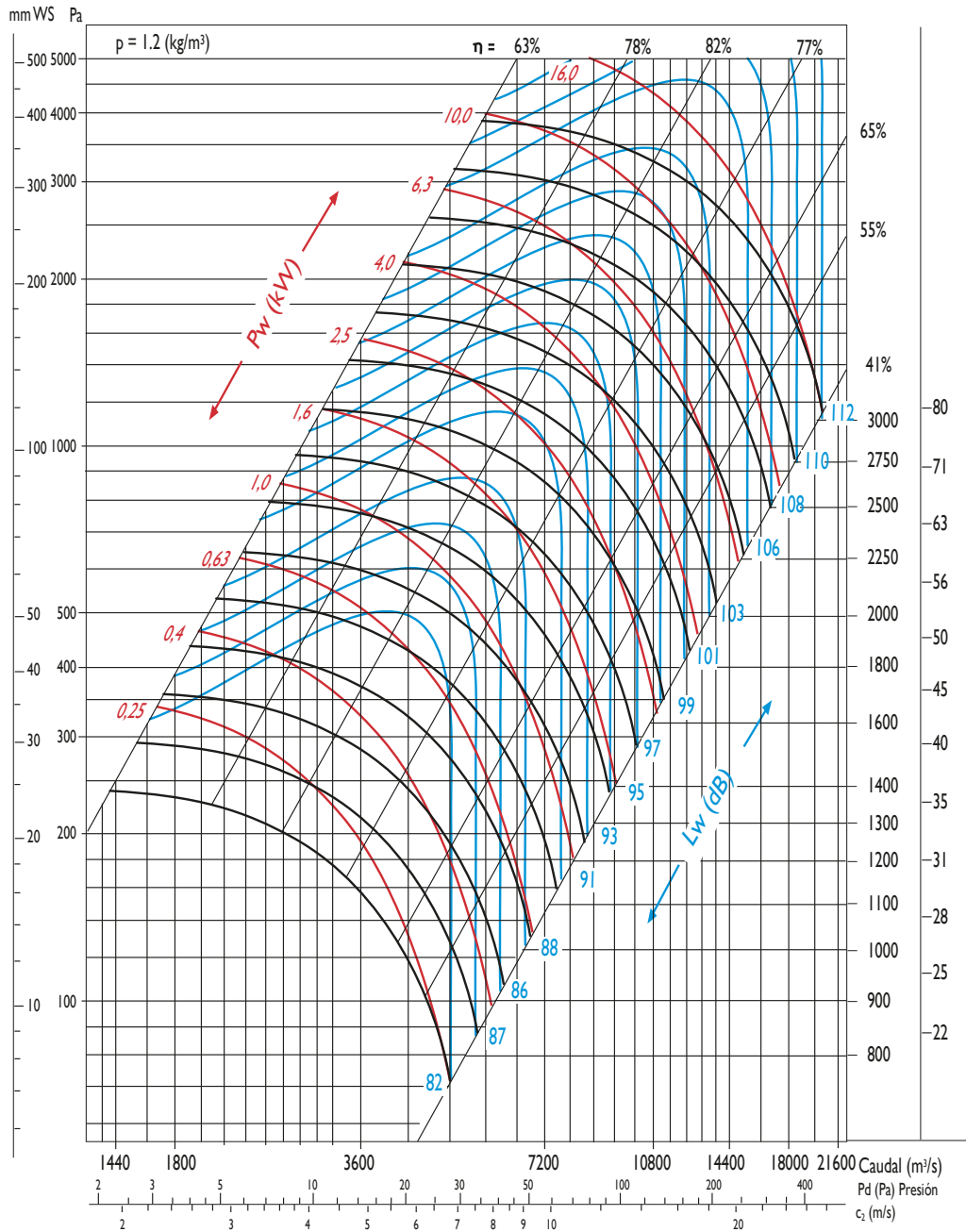

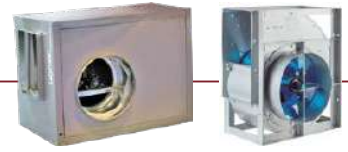

560

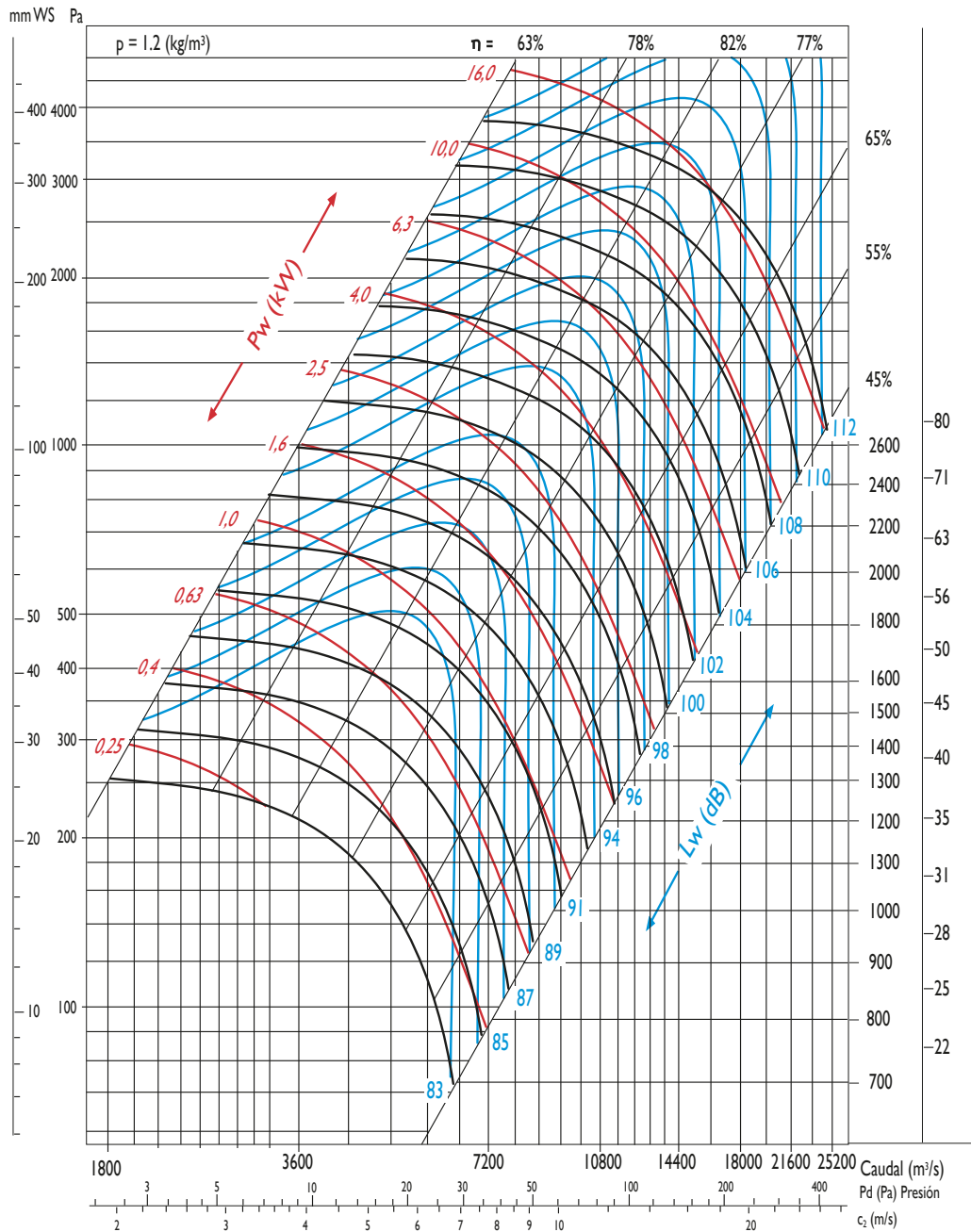



630

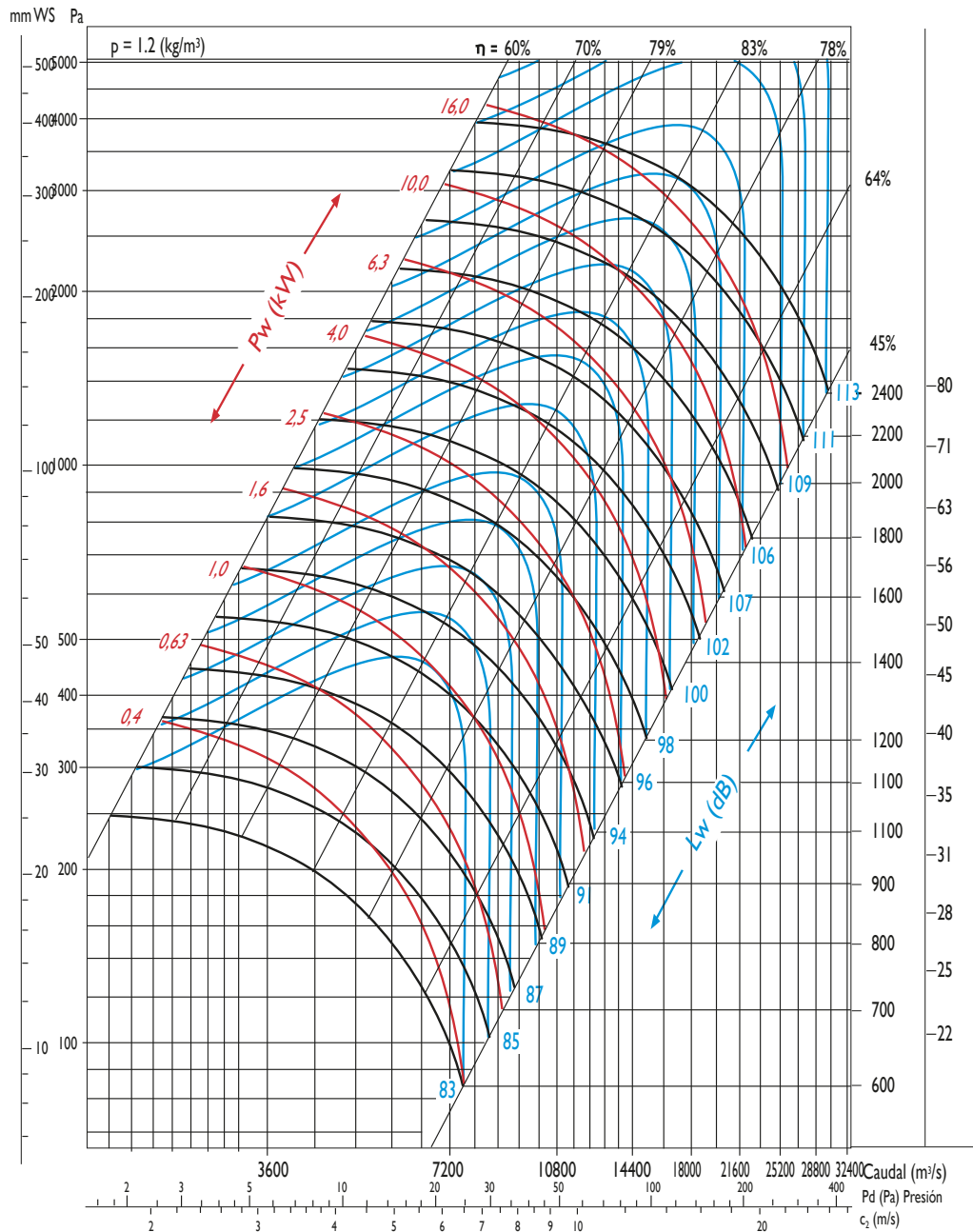



710

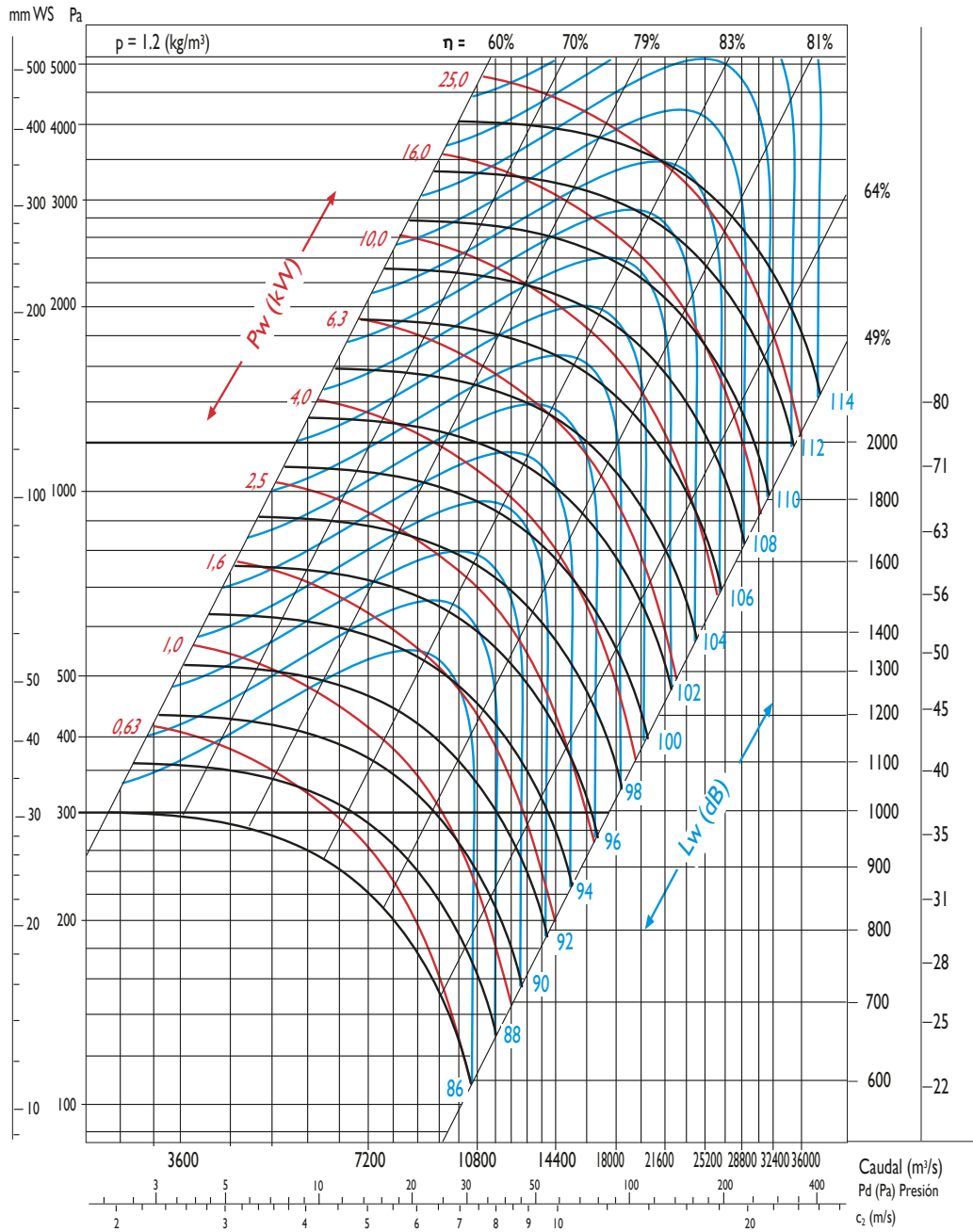



800

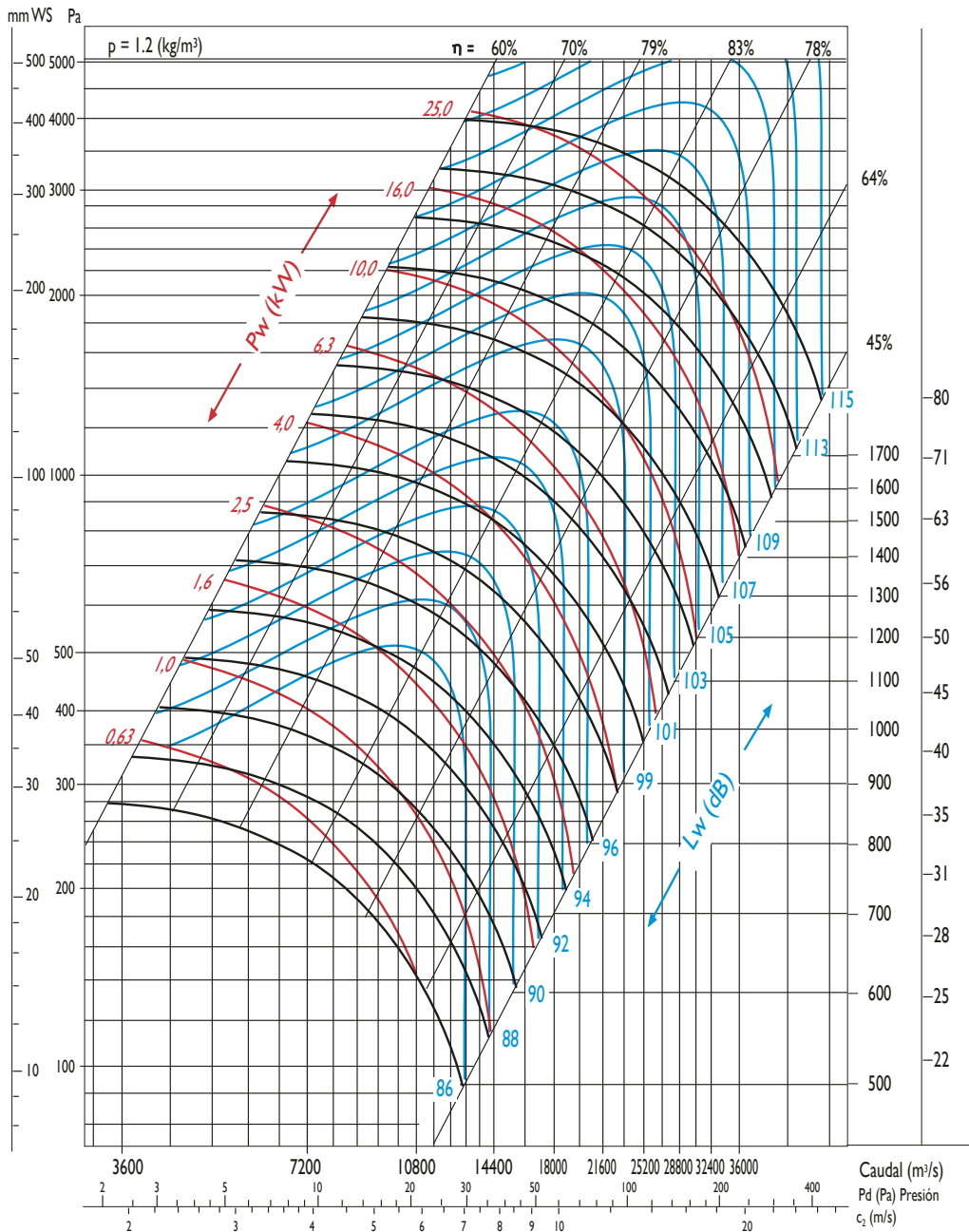



900

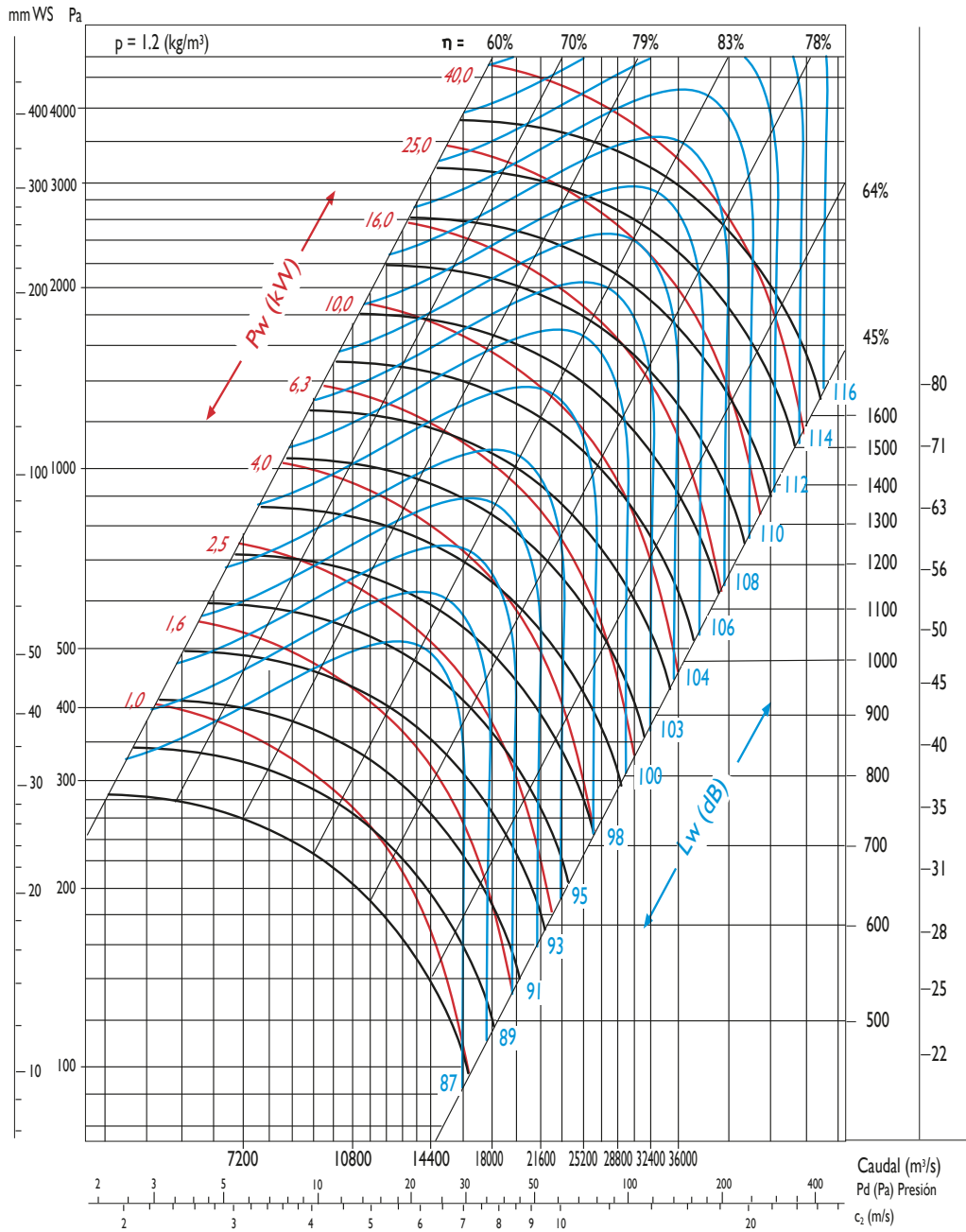



1000

