

Luymar

... un uso eficiente del aire

BT-Z-SA
CBT-Z-SA
THLE

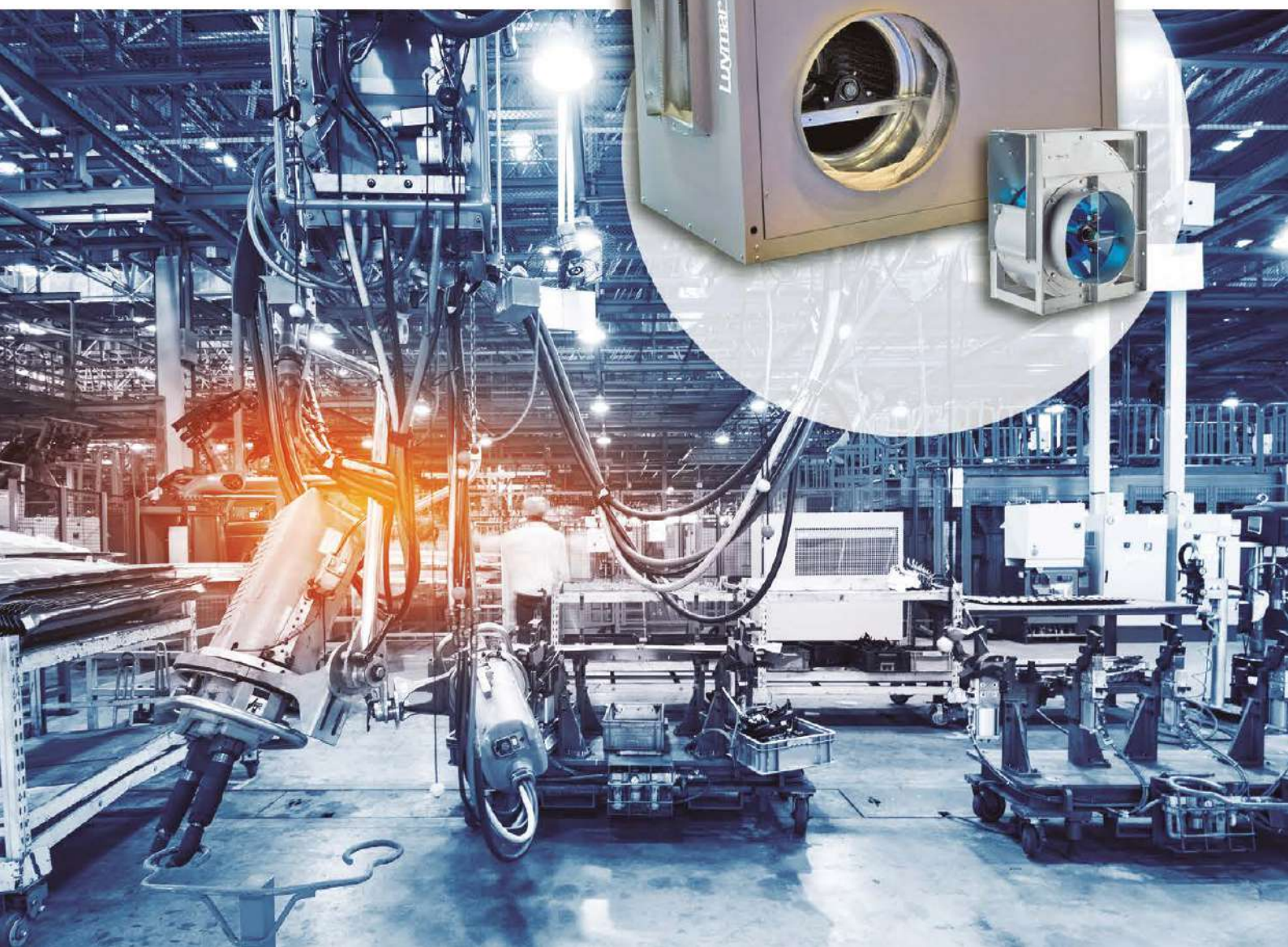



VENTILADOR SIMPLE OÍDO A REACCIÓN, MEDIA PRESIÓN

- Ventilador simple oído con rodete de reacción.
- 14 tamaños diferentes.
- Diseño compacto para proporcionar una alta eficiencia y alta calidad de ejecución.
- Caudales desde 2.500 a más de 100.000 m³/h.

CBT-Z-SA VENTILADOR SIMPLE OÍDO, MEDIA PRESIÓN, CON CAJA

- Cajas de ventilación equipadas con ventiladores de rodete de reacción, palas hacia atrás, media-alta presión, simple oído, transmisión por poleas y correas.
- Construidas en chapa de acero galvanizado y aisladas térmica y acústicamente.

BXT-Z SINGLE INLET REACTION, HALF PRESSURE, 400°C / 2h WITH BOX

- Single inlet (400°C / 2h) with reaction impeller.
- Certificate Certiberia 2426-CPR-111 (EN12101-7: 2011).
- 14 different sizes.
- Compact design to provide high efficiency and high quality of operation.
- Flow rates from 2.500 to more than 100.000 m³ / h.

CBXT-Z SINGLE INLET FAN, HALF PRESSURE, WITH BOX

- 400°C/2h ventilation boxes equipped with reaction impeller fans, backward blade, medium-high pressure, single inlet, pulley and belt propulsion.
- Manufactured in galvanized steel sheet and insulated thermally and acoustically.

BXT-Z VENTILATEUR SIMPLE OUIË, DEMI-PRESSION, 400°C/2h AVEC BOITE

- Ventilateur mono-ouïe (400°C/2h) avec turbine à réaction.
- Certificat Certiberia 2426-CPR-111 (EN12101-7: 2011).
- 14 tailles différentes.
- Conception compacte pour fournir une grande efficacité et une haute qualité d'exécution.
- Débit de 2.500 à plus de 100.000 m³/h.

CBXT-Z VENTILATEUR SIMPLE OUIË, DEMI-PRESSION, AVEC BOÎTE

- Caissons de ventilation 400°C/2h équipés de ventilateurs avec roue à réaction, pelles en arrière, moyenne-haute pression, simple ouïe, transmission par poulies et courroies.
- Construit en tôle d'acier galvanisé et isolé thermiquement et acoustiquement.

BT-Z-SA / CBT-Z-SA / THLE

MODELO BT-Z-SA / CBT-Z-SA	Velocidad (r/min.)	Potencia (kW)	Caudal (m³/h)	l. máx. (A)			Peso (kg)	Presión Acústica (dB(A))*	BT-Z-SA	CBT-Z-SA
				230V	400V	690V			Código	Código
315 - 0,75 cv	2520	0,55	4000	2,74	1,58		33	84	0347031503	0347231503
315 - 1 cv	2800	0,75	4500	3,0	1,8		35	84	0347031504	0347231504
315 - 1,5 cv	3250	1,1	5050	4,3	2,5		40	87	0347031505	0347231505
315 - 2 cv	3550	1,5	5650	5,7	3,3		45	91	0347031506	0347231506
315 - 3 cv	3700	2,2	6400	7,8	4,5		53	91	0347031507	0347231507
355 - 0,75 cv	2100	0,55	4750	2,74	1,58		45	82	0347035503	0347235503
355 - 1 cv	2300	0,75	5200	3,0	1,8		47	85	0347035504	0347235504
355 - 1,5 cv	2600	1,1	6000	4,3	2,5		51	87	0347035505	0347235505
355 - 2 cv	2875	1,5	6650	5,7	3,3		56	89	0347035506	0347235506
355 - 3 cv	3350	2,2	7500	7,8	4,5		65	91	0347035507	0347235507
355 - 4 cv	3400	3	8200	10,4	6,0		70	95	0347035508	0347235508
400 - 1 cv	1900	0,75	6100	3,0	1,8		56	84	0347040004	0347240004
400 - 1,5 cv	2180	1,1	7000	4,3	2,5		60	86	0347040005	0347240005
400 - 2 cv	2400	1,5	7700	5,7	3,3		65	87	0347040006	0347240006
400 - 3 cv	2750	2,2	8800	7,8	4,5		74	90	0347040007	0347240007
400 - 4 cv	3050	3	9800	10,4	6,0		79	95	0347040008	0347240008
400 - 5,5 cv	3300	4	10500	13,8	8,0		96	96	0347040009	0347240009
450 - 1 cv	1380	0,75	6500	3,0	1,8		83	81	0347040004	0347240004
450 - 1,5 cv	1550	1,1	7500	4,3	2,5		87	85	0347040005	0347240005
450 - 2 cv	1700	1,5	8050	5,7	3,3		92	87	0347040006	0347240006
450 - 3 cv	1950	2,2	9050	7,8	4,5		101	88	0347040007	0347240007
450 - 4 cv	2200	3	10100	10,4	6,0		106	93	0347040008	0347240008
450 - 5,5 cv	2400	4	11500	13,8	8,0		123	95	0347040009	0347240009
450 - 7,5 cv	2600	5,5	12500		10,7		132	98	0347040010	0347240010
500 - 1,5 cv	1250	1,1	8200	4,3	2,5		96	83	0347050005	0347250005
500 - 2 cv	1380	1,5	9000	5,7	3,3	6,2	101	86	0347050006	0347250006
500 - 3 cv	1560	2,2	10200	7,8	4,5		110	88	0347050007	0347250007
500 - 4 cv	1730	3	11500	10,4	6,0		115	91	0347050008	0347250008
500 - 5,5 cv	1900	4	12500	13,8	8,0		132	93	0347050009	0347250009
500 - 7,5	2130	5,5	14000		10,7		141	96	0347050010	0347250010
500 - 10 cv	2300	7,5	15500		14,3		156	98	0347050011	0347250011
560 - 2 cv	1200	1,5	11000	5,7	3,3	6,2	134	85	0347056006	0347256006
560 - 3 cv	1380	2,2	12200	7,8	4,5	8,3	143	88	0347056007	0347256007
560 - 4 cv	1500	3	14000	10,4	6,0		148	90	0347056008	0347256008
560 - 5,5 cv	1670	4	15500	13,8	8,0		165	93	0347056009	0347256009
560 - 7,5 cv	1850	5,5	16200		10,7		174	95	0347056010	0347256010
560 - 10 cv	1900	7,5	18300		14,3		189	98	0347056011	0347256011
560 - 15 cv	2000	11	21000		20,4	6,2	200	99	0347056013	0347256013
630 - 3 cv	1060	2,2	13200	7,8	4,5	8,3	166	87	0347063007	0347263007
630 - 4 cv	1150	3	14400	10,4	6,0	11,8	171	89	0347063008	0347263008
630 - 5,5 cv	1300	4	16000	13,8	8,0		188	91	0347063009	0347263009
630 - 7,5 cv	1450	5,5	18000		10,7	6,2	197	94	0347063010	0347263010
630 - 10 cv	1600	7,5	19800		14,3	8,3	212	96	0347063011	0347263011
630 - 15 cv	1700	11	23040		20,4	11,8	224	97	0347063013	0347263013
710 - 4 cv	1000	3	17280	10,4	6,0		241	89	0347071008	0347271008
710 - 5,5 cv	1100	4	19080	13,8	8,0		258	90	0347071009	0347271009
710 - 7,5 cv	1200	5,5	20880		10,7	6,2	267	87	0347071010	0347271010
710 - 10 cv	1350	7,5	23760		14,3	8,3	282	94	0347071011	0347271011
710 - 15 cv	1550	11	27720		20,4	11,8	294	98	0347071013	0347271013
710 - 20 cv	1600	15	29880		17,3	15,8	315	100	0347071014	0347271014
710 - 25 cv	1650	18,5	32100		33,5	19,3	369	101	0347071015	0347271015

* Presión acústica a 1,5m

Luymar

MODELO BT-Z-SA / CBT-Z-SA	Velocidad (r/min.)	Potencia (kW)	Caudal (m³/h)	I. máx. (A)			Peso (kg)	Presión Acústica (dB(A))*	BT-Z-SA	CBT-Z-SA
				230V	400V	690V			Código	Código
800 - 5,5 cv	800	4	22680	13,8	8,0		298	88	0347080009	-
800 - 7,5 cv	970	5,5	25100		10,7	6,2	307	91	0347080010	-
800 - 10 cv	1070	7,5	27720		14,3	8,3	322	93	0347080011	-
800 - 15 cv	1230	11	32040		20,4	11,8	334	96	0347080013	-
800 - 20 cv	1350	15	34000		27,3	15,8	355	98	0347080014	-
800 - 25 cv	1450	18,5	37800		33,5	19,3	409	101	0347080015	-
900 - 5,5 cv	720	4	26000	13,8	8,0		378	87	0347090009	-
900 - 7,5 cv	790	5,5	29500		10,7	6,2	387	90	0347090010	-
900 - 10 cv	860	7,5	32100		14,3	8,3	402	93	0347090011	-
900 - 15 cv	1020	11	37900		20,4	11,8	414	97	0347090013	-
900 - 20 cv	1120	15	42000		27,3	15,8	435	98	0347090014	-
900 - 25 cv	1190	18,5	43500		33,5	19,3	489	100	0347090015	-
900 - 30 cv	1250	22	45000		39,7	22,9	533	104	0347090016	-
1000 - 7,5 cv	660	5,5	33000		10,7	6,2	447	89	0347100010	-
1000 - 10 cv	730	7,5	37000		14,3	8,3	462	92	0347100011	-
1000 - 15 cv	840	11	42500		20,4	11,8	474	95	0347100013	-
1000 - 20 cv	940	15	46000		27,3	15,8	495	97	0347100014	-
1000 - 25 cv	1000	18,5	50000		33,5	19,3	549	99	0347100015	-
1000 - 30 cv	1060	22	52500		39,7	22,9	593	101	0347100016	-
1000 - 40 cv	1160	30	59000		53,8	31,1	613	105	0347100017	-

* Presión acústica a 1,5m

TAMAÑO	SIMPLE ASPIRACION
	RODETE REACCION
	THLE Código
200 R	037THLE0200
225 R	037THLE0252
250 R	037THLE0250
280 R	037THLE0280
315 R	037THLE0315
355 T	037THLE0355
400 T	037THLE0400
450 T	037THLE0450
500 T	037THLE0500
560 T	037THLE0560
630 T	037THLE0630
710 T	037THLE0710
800 T	037THLE0800
900 T	037THLE0900
1000 T	037THLE1000



DIMENSIONES

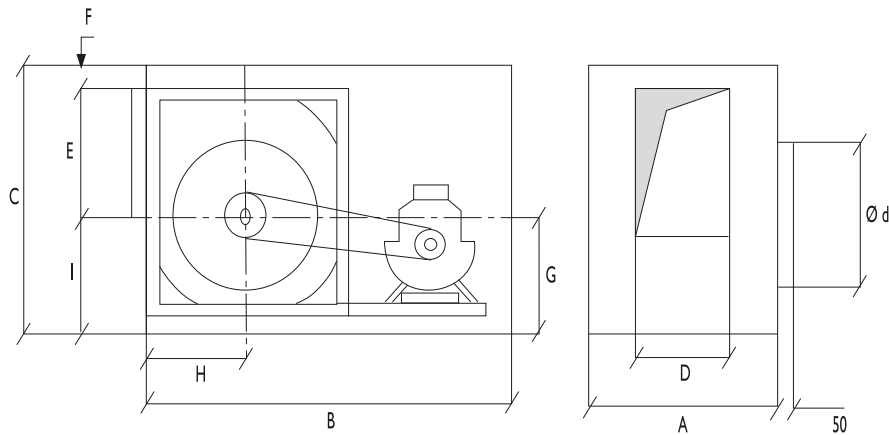

MODELO	MEDIDAS DE LAS CAJAS EN mm.									IMPULSIÓN VERTICAL		
	A	B	C	D	E	G	H	F	Ød	C ₁	B ₁	F ₁
225	500	700	522	175	272	240	225	68	225			
250	516	750	575	190	297	251	265	79	250			
280	540	850	650	225	360	290	304	65	280			
315	540	850	650	275	415	325	335	84	315			
355	600	1000	755	275	415	325	335	84	355			
400	620	1200	875	308	487	382	360	78	400			
450	620	1272	967	322	611	477	430	177	450	1080	1380	40
500	730	1300	1175	355	699	515	450	165	500	1146	1510	40
560	763	1403	1250	355	699	515	450	165	560	1146	1510	40
630	823	1503	1380	414	799	573	460	170	630	1226	1655	40
710	857	1653	1600	471	939	702	570	121	710	1431	1875	40



315

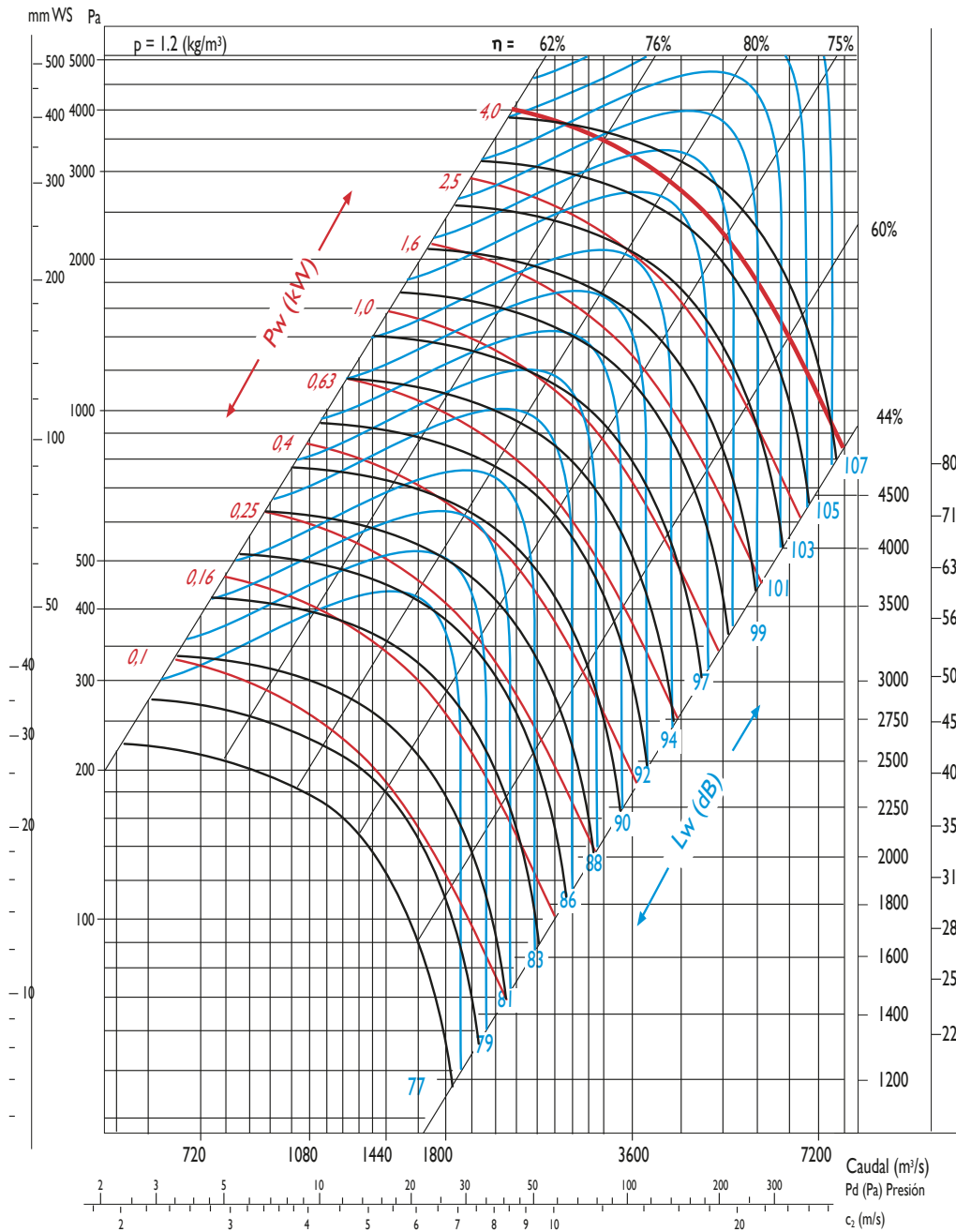

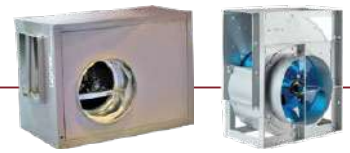

355

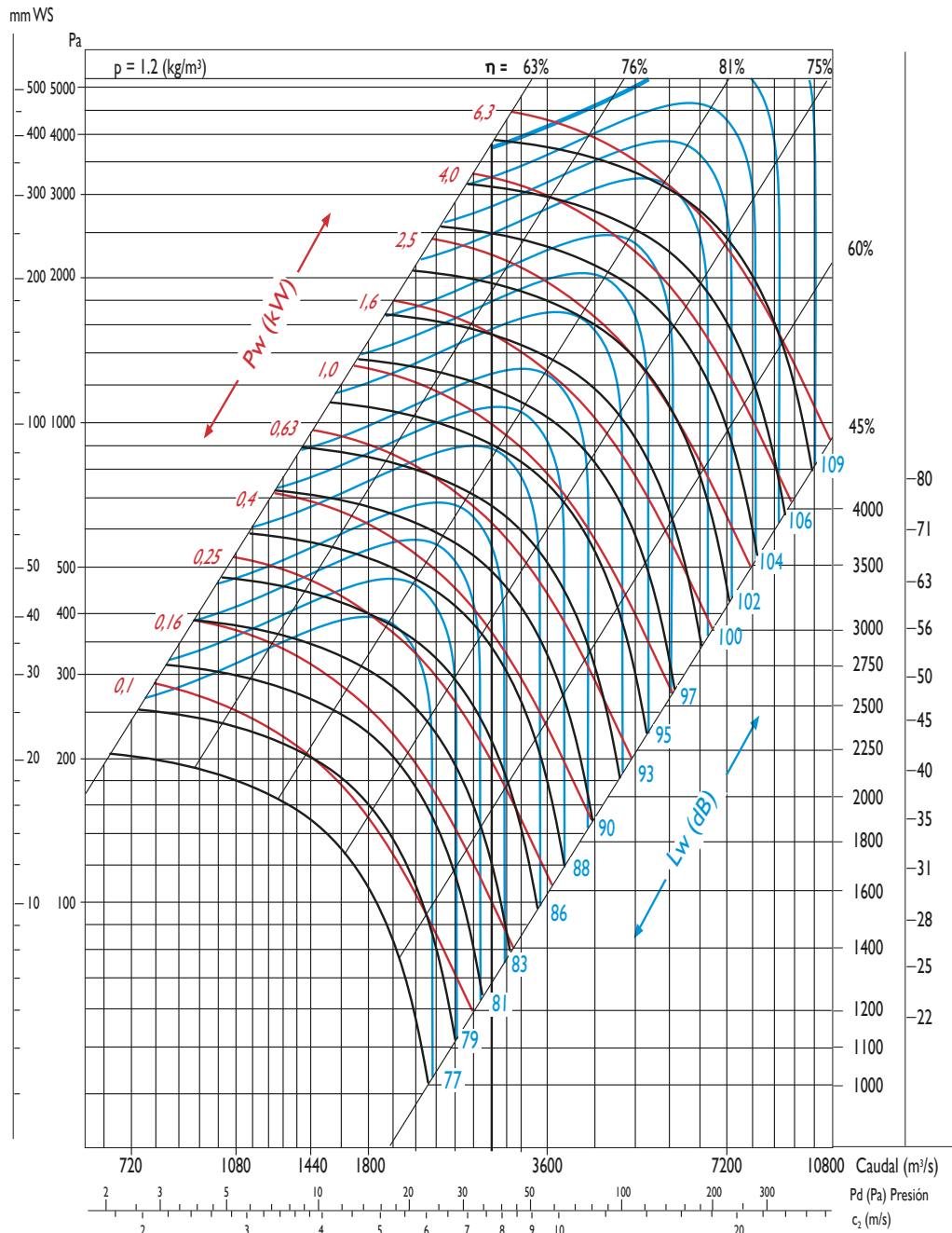



400

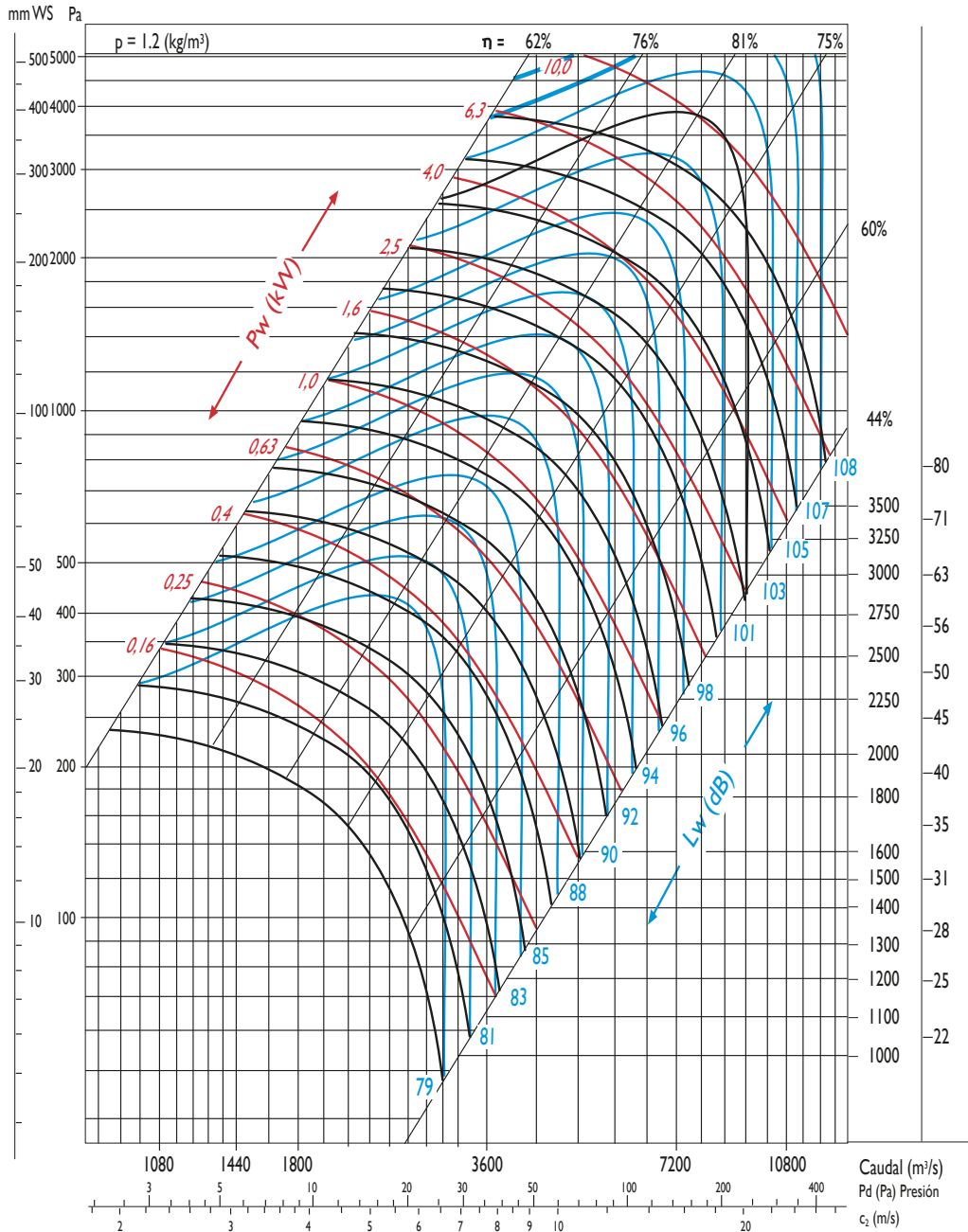



450

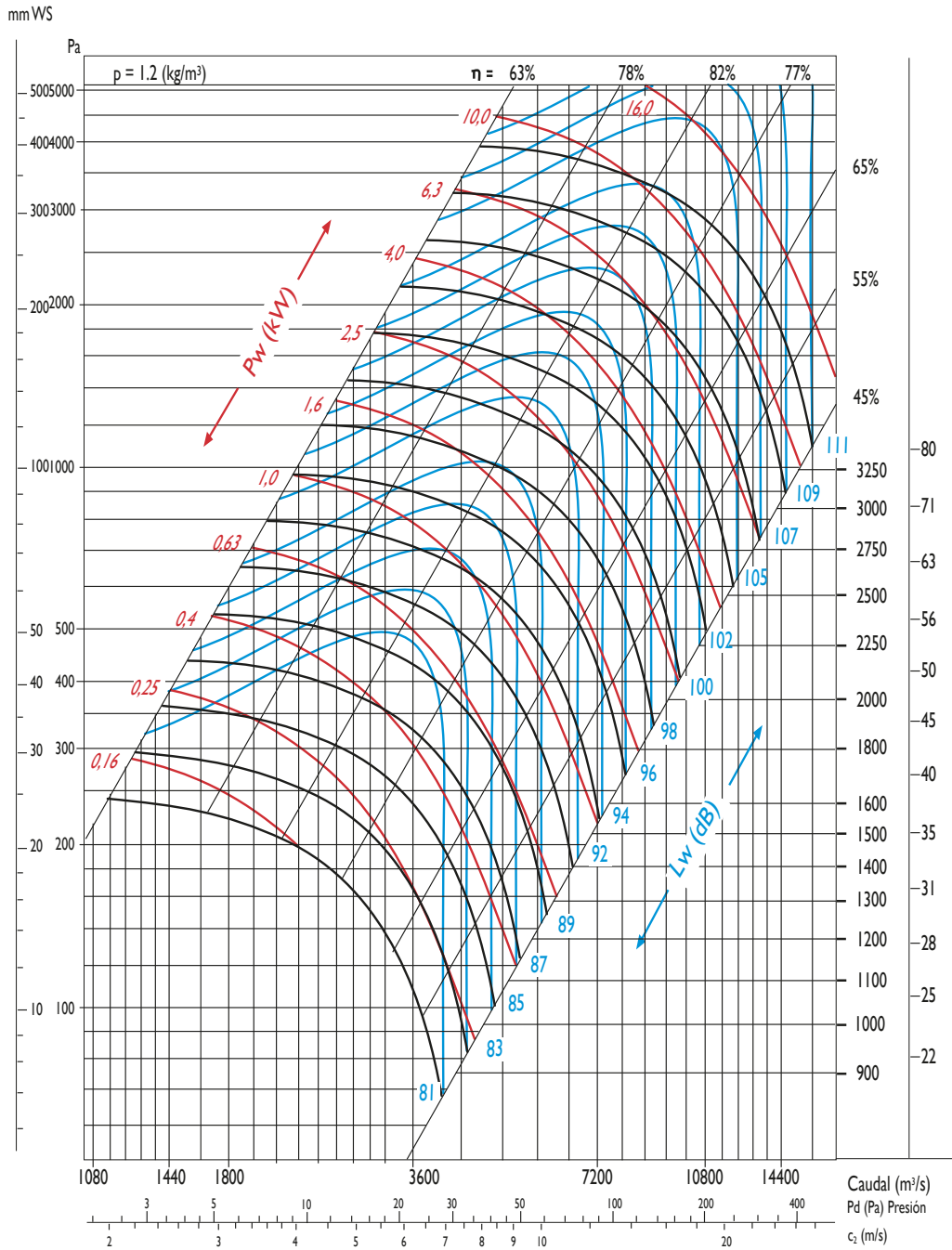



500

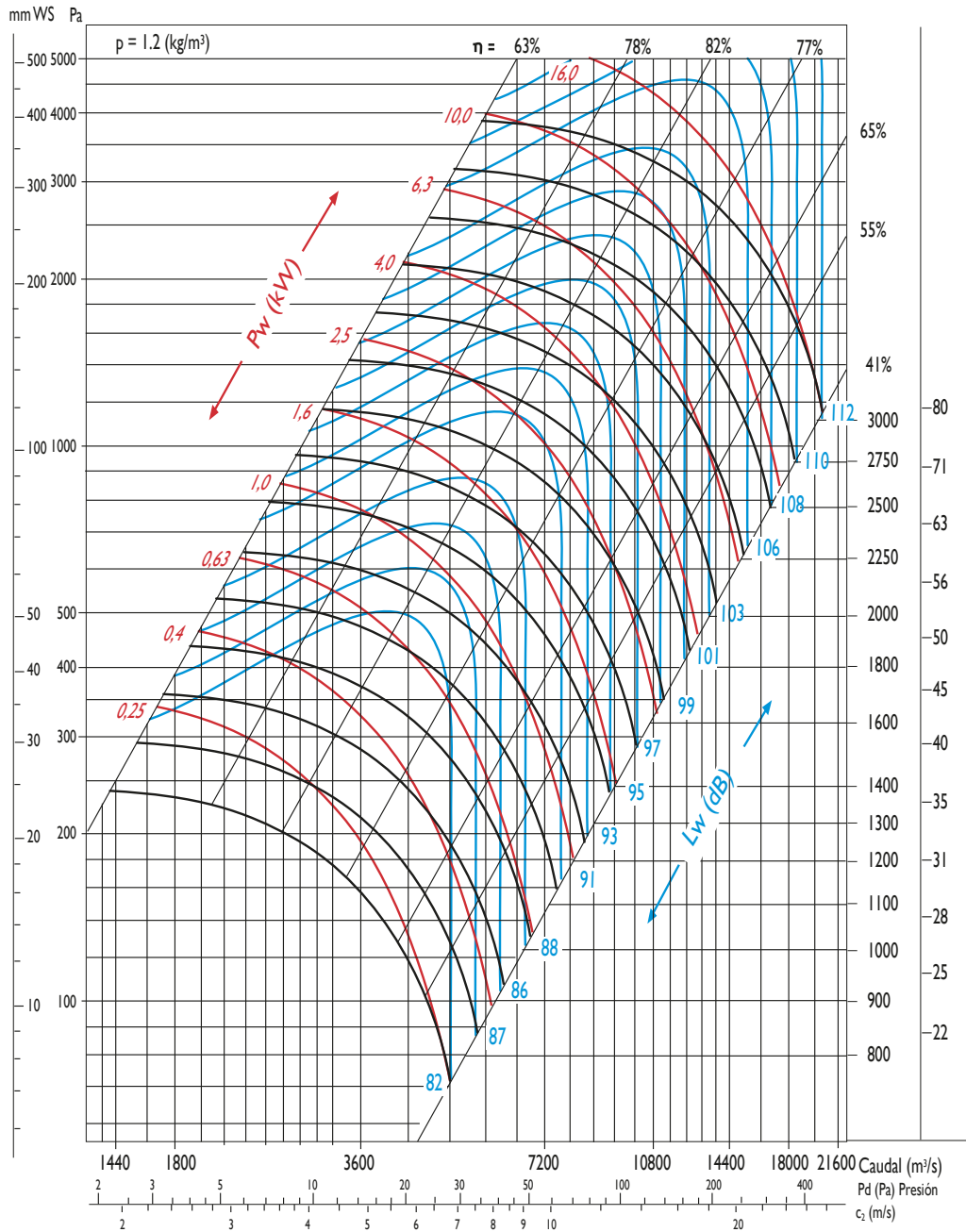



560

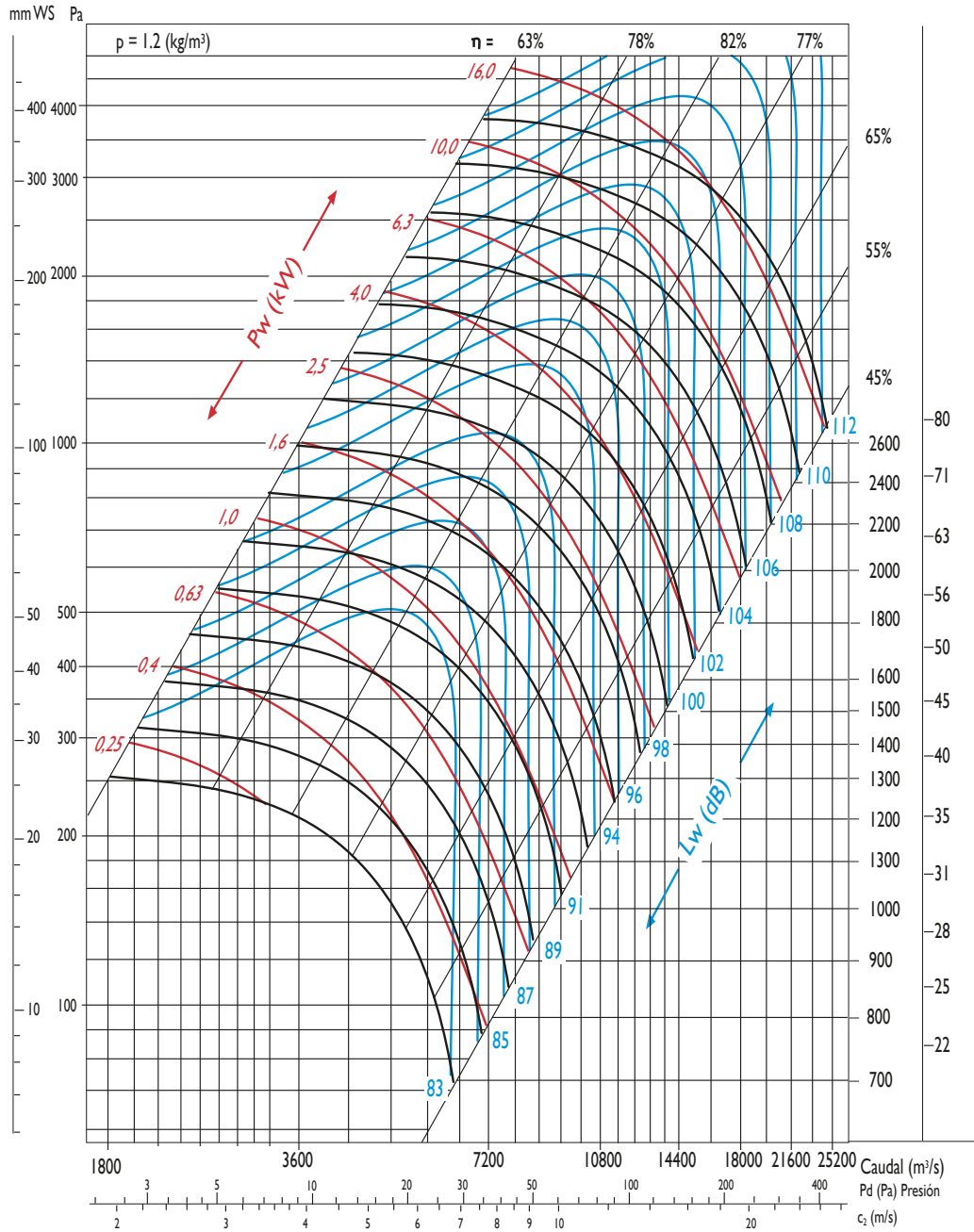



630

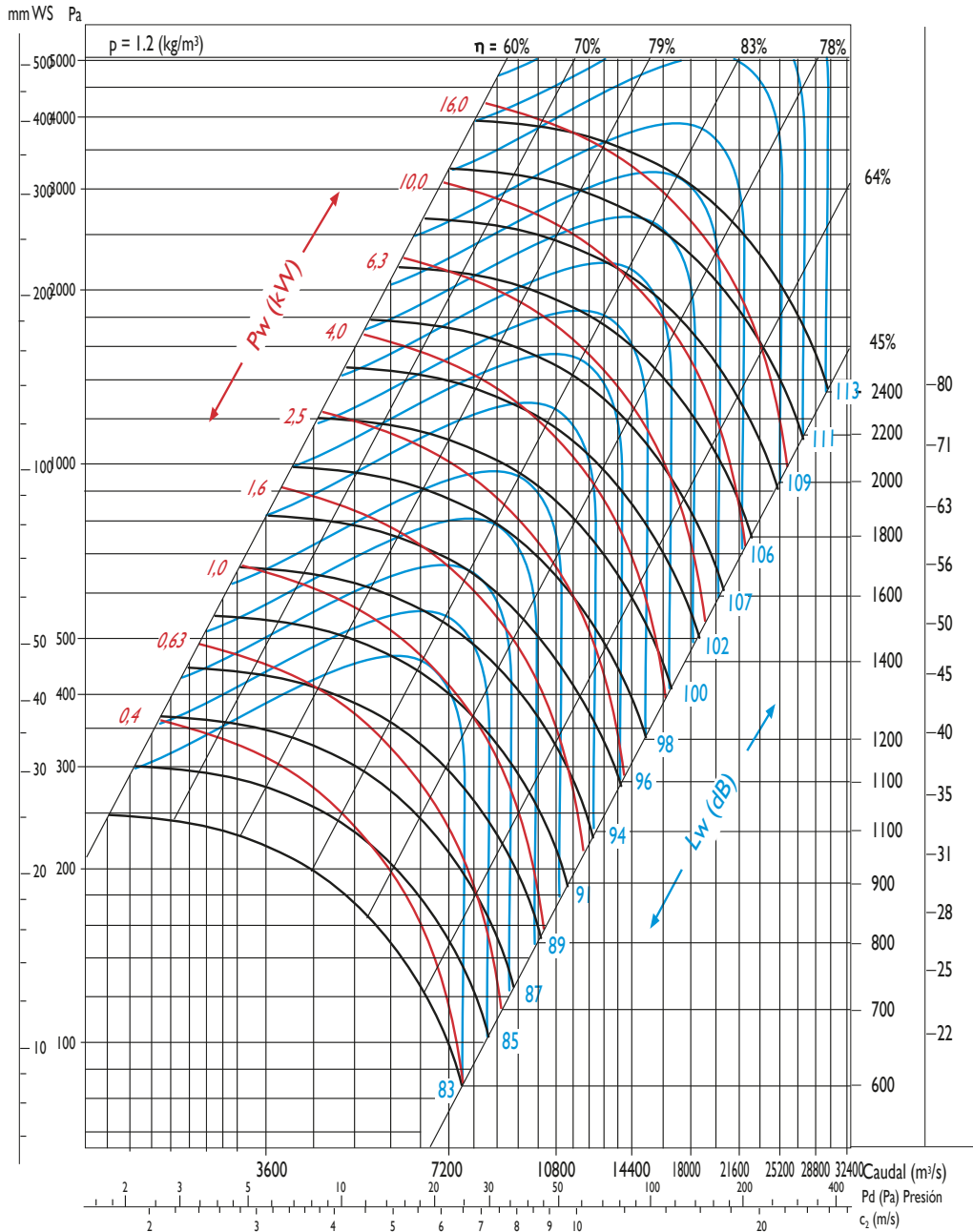



710

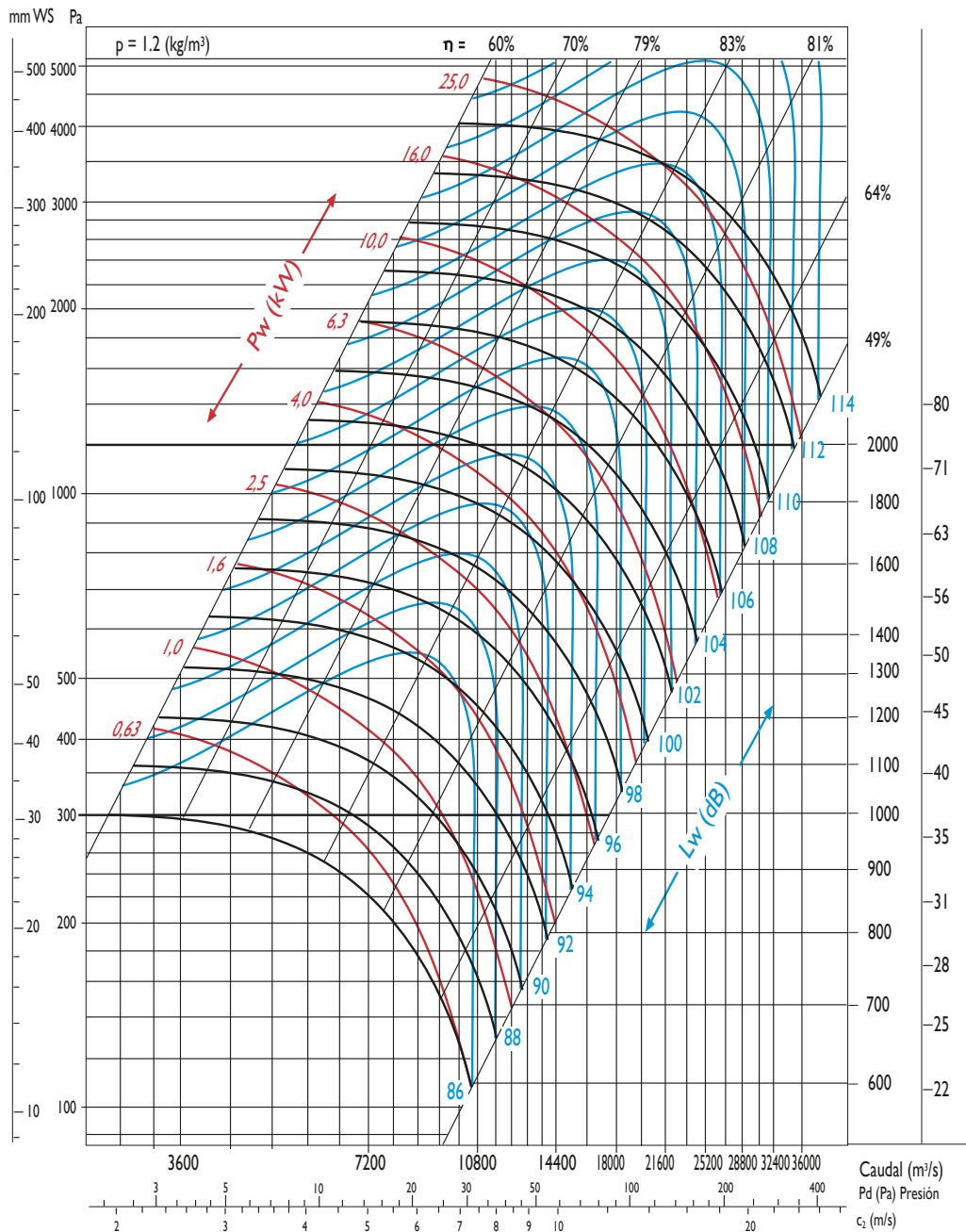



800

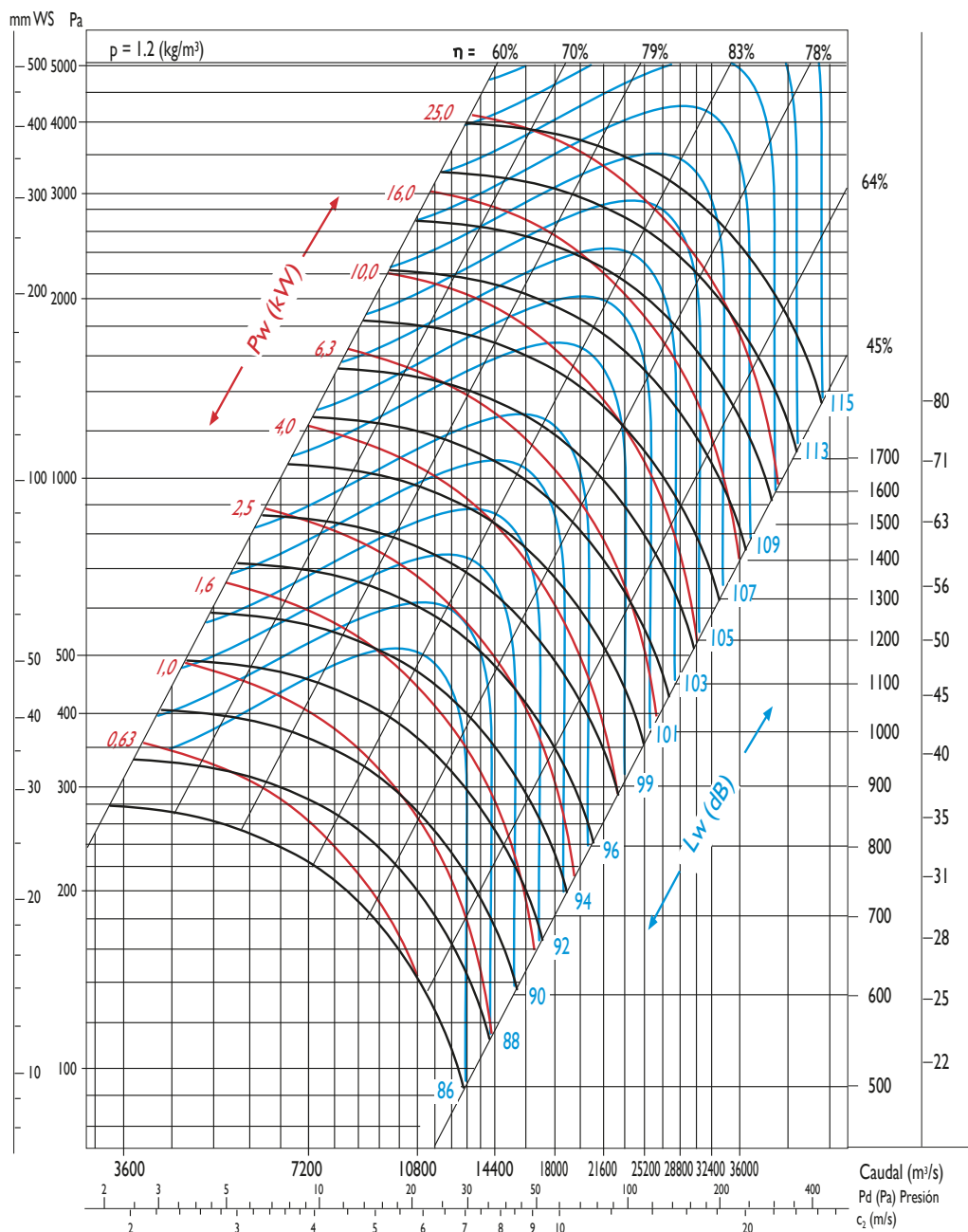

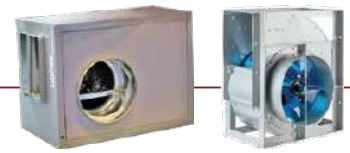

900

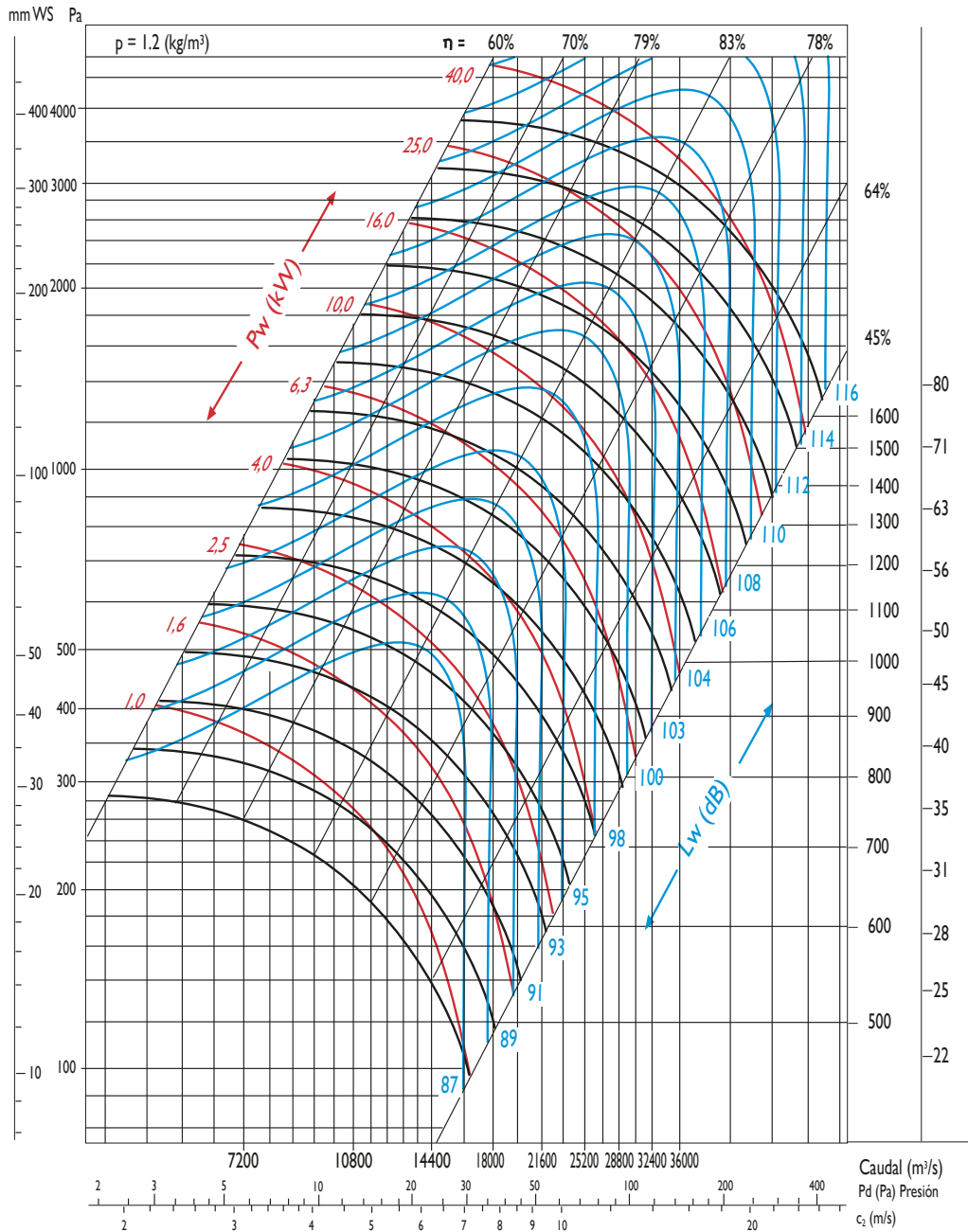



1000

