

Luymar

... un uso eficiente del aire

BT-SA

CBT-SA

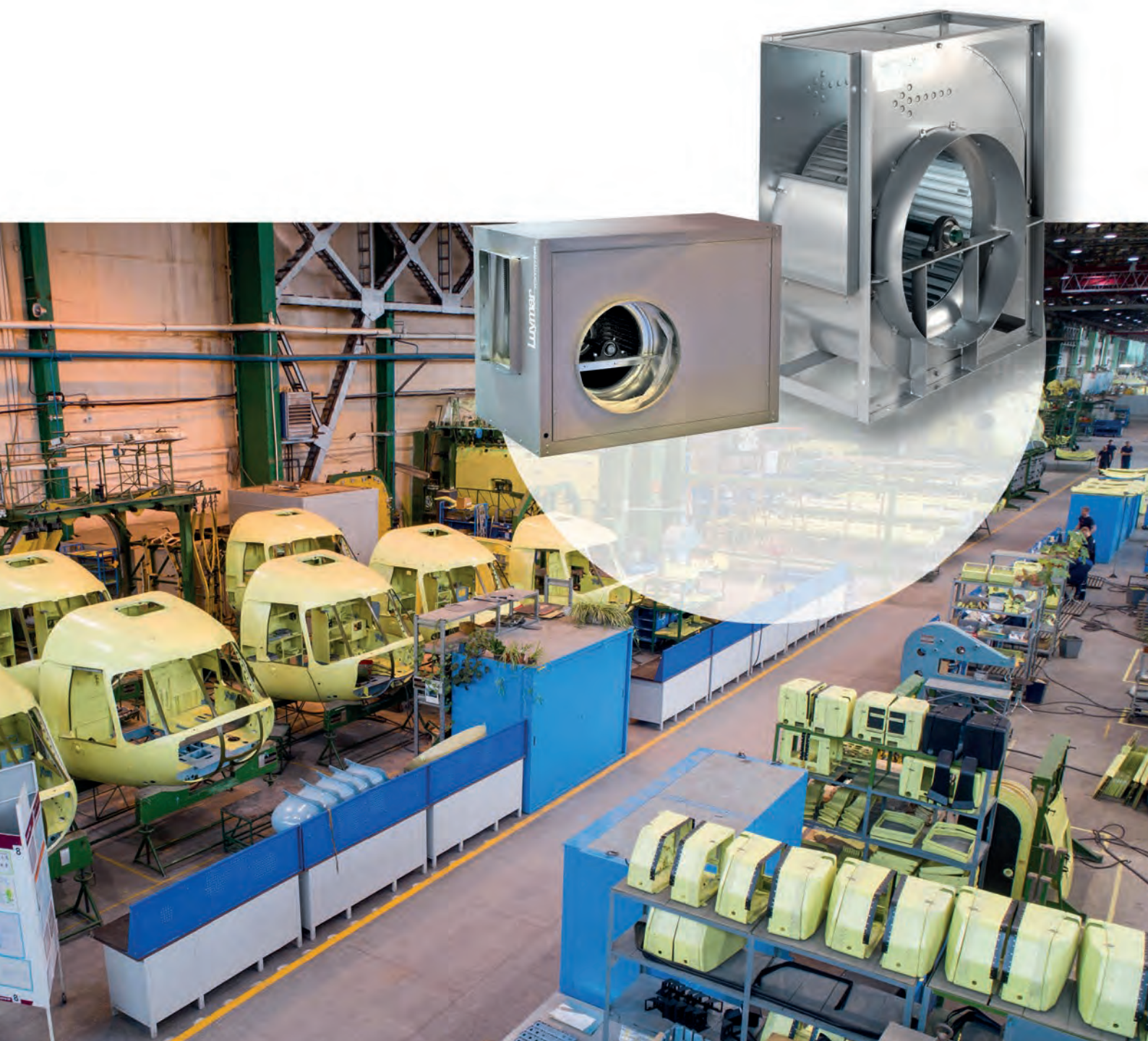



BT-SA VENTILADOR SIMPLE OÍDO

- Ventiladores, SIMPLE ASPIRACIÓN.
- Accionamiento a través de poleas.
- Motores 230/400V 50/60Hz hasta 4cv y 380/660V 50/60Hz para potencias superiores. Eficiencia IE3 a partir de 1cv.

CBT-SA Cajas de ventilación a transmisión de simple oído

- Cajas de ventilación construidas en chapa de acero galvanizado equipadas con ventiladores centrífugos de baja presión, simple oído 400°C, a transmisión por poleas.
- Aislamiento interior térmico y acústico con espuma no inflamable M1.
- Ventilador montado sobre soportes anti-vibratorios y junta flexible en admisión y descarga.
- Con tapas de registro para acceder al ventilador y motor.
- Bajo demanda se puede suministrar el ventilador con descarga vertical.

BT-SA SINGLE INLET

- Fans, SIMPLE SUCTION.
- Propelled by pulleys.
- 230 / 400V 50 / 60Hz up to 4cv and 380 / 660V 50 / 60Hz motors for higher powers. IE3 Efficiency from 1cv.

CBT-SA Single inlet transmission ventilation boxes

- Ventilation boxes manufactured in galvanized steel sheet equipped with low pressure centrifugal fans, 400°C single inlet, pulley propelled.
- Interior thermal and acoustic insulation with non-flammable M1 foam.
- Fan mounted on anti-vibration supports and flexible joint in admission and discharge.
- With inspection lids to access the fan and motor.
- On demand, the fan can be supplied with vertical discharge.



BT-SA VENTILATEUR SIMPLE OUIÉ

- Ventilateurs, ASPIRATION SIMPLE.
- l'entraînement par poulies.
- Moteurs 230 / 400V 50 / 60Hz jusqu'à 4cv et 380 / 660V 50 / 60Hz pour des puissances supérieures. Efficacité IE3 de 1cv.

CBT-SA Boîtes de Ventilation de Transmission à Simple Ouié

- Caisses de ventilation en tôle d'acier galvanisée équipée de ventilateurs centrifuges basse pression, une seule ouïe 400°C, entraînée par poulie.
- Isolation thermique et acoustique intérieure avec mousse M1 ininflammable.
- Ventilateur monté sur supports anti-vibratoires et joint souple en admission et refoulement.
- Avec des bouchons d'enregistrement pour accéder au ventilateur et au moteur.
- Sur demande, le ventilateur peut être fourni avec une décharge verticale.

MODELO BT-SA / CBT-SA	Velocidad (r/min.)	Potencia (kW)	Caudal (m ³ /h)	I. máx. (A)			Peso (kg)	Presión Acústica (dB(A))*	BT-SA	CBT-SA
				230V	400V	690V			Código	Código
9/4 - 0,5	1450	0,37	1500	1,92	1,11		37	68	03090904021	03100904021
9/4 - 0,75	1450	0,55	1700	2,74	1,58		40	71	03090904031	03100904031
9/4 - 1	1230	0,75	2000	3,0	1,8		42	74	03090904041	03100904041
10/5- 0,5	1230	0,37	2100	1,92	1,11		42	69	03091005021	03101005021
10/5- 0,75	1450	0,55	2500	2,74	1,58		45	72	03091005031	03101005031
10/5- 1	1450	0,75	3000	3,0	1,8		47	74	03091005041	03101005041
12/6- 0,75	990	0,55	2600	2,74	1,58		73	69	03091206031	03101206031
12/6- 1	1100	0,75	3100	3,0	1,8		74	71	03091206041	03101206041
12/6- 1,5	1230	1,10	3500	4,3	2,5		77	74	03091206051	03101206051
12/6- 2	1300	1,50	4250	5,7	3,3		80	77	03091206061	03101206061
12/6- 3	1450	2,20	4800	7,8	4,5		85	79	03091206071	03101206071
15/7- 1	770	1,75	4000	3,0	1,8		92	67	03091507041	03101507041
15/7- 1,5	880	1,10	4800	4,3	2,5		95	69	03091507051	03101507051
15/7- 2	910	1,50	5400	5,7	3,3		98	72	03091507061	03101507061
15/7- 3	990	2,20	6400	7,8	4,5		103	75	03091507071	03101507071
15/7- 4	910	3,00	7400	10,4	6,0		106	77	03091507081	03101507081
18/9- 1,5	770	1,10	5800	4,3	2,5		111	68	03091809051	03101809051
18/9- 2	810	1,50	6600	5,7	3,3		114	70	03091809061	03101809061
18/9- 3	770	2,20	8200	7,8	4,5		119	74	03091809071	03101809071
18/9- 4	810	3,00	9000	10,4	6,0		122	76	03091809081	03101809081
18/9- 5,5	910	4,00	10500	13,8	8,0		125	78	03091809091	03101809091
20/10- 2	650	1,50	8100	5,7	3,3		203	65	03092010061	03102010061
20/10- 3	685	2,20	10100	7,8	4,5		208	68	03092010071	03102010071
20/10- 4	725	3,00	11500	10,4	6,0		211	70	03092010081	03102010081
20/10- 5,5	810	4,00	13100	13,8	8,0		214	73	03092010091	03102010091
20/10- 7,5	900	5,50	15000		10,7	6,2	227	75	03092010101	03102010101
22/11- 3	650	2,20	11200	7,8	4,5		219	67	03092211071	03102211071
22/11- 4	580	3,00	13000	10,4	6,0		222	70	03092211081	03102211081
22/11- 5,5	725	4,00	15000	13,8	8,0		225	72	03092211091	03102211091
22/11- 7,5	650	5,50	17000		10,7	6,2	238	74	03092211101	03102211101
22/11- 10	725	7,50	19000		14,3	8,3	246	76	03092211111	03102211111
25/13- 4	520	3,00	14000	10,4	6,0		254	62	03092513081	03102513081
25/13- 5,5	650	4,00	17000	13,8	8,0		257	65	03092513091	03102513091
25/13- 7,5	575	5,50	19500		10,7	6,2	270	67	03092513101	03102513101
25/13-10	650	7,50	23000		14,3	8,3	278	70	03092513111	03102513111
30/14- 5,5	400	4,00	21000	13,8	8,0		331	69	03093014091	03103014091
30/14- 7,5	460	5,50	24000		10,7	6,2	344	72	03093014101	03103014101
30/14- 10	450	7,50	27500		14,3	8,3	352	74	03093014111	03103014111

* Presión acústica a 1,5m

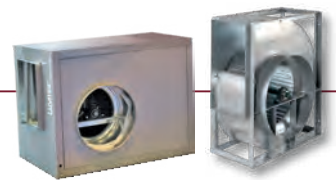

BT-SA - tamaños 9/4 a 18/9 - pequeños

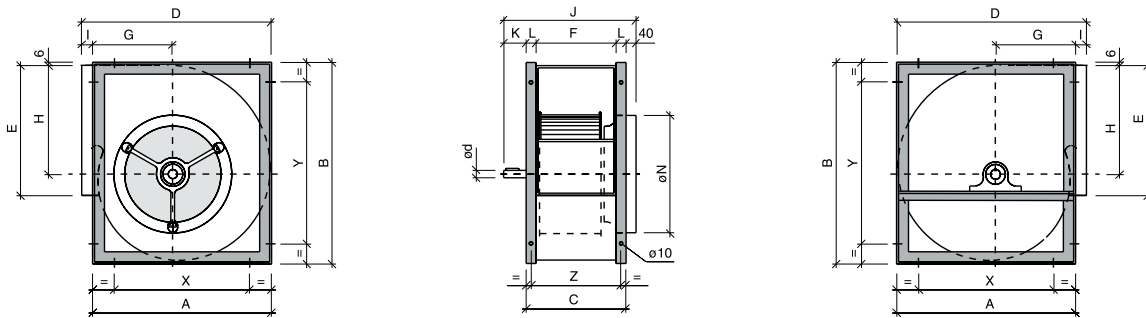

TAMAÑO	A	B	C	D	E	F	G	H	I	J	K	ød	L	øN	X	Y	Z
9 / 4	355	404	217	380	265	169	155	218	25	297	40	20	24	248	280	327	193
10 / 5	402	452	230	432	290	182	177	245	30	310	40	20	24	278	326	377	206
12 / 6	475	534	268	505	342	210	203	290	30	358	50	25	29	313	384	453	240
15 / 7	553	622	329	583	404	271	238	343	30	417	50	25	29	398	460	531	300
18 / 9	666	754	368	700	480	298	285	417	34	458	50	25	35	448	553	641	333

BT-SA - tamaños 20/10 a 30/14 - grandes

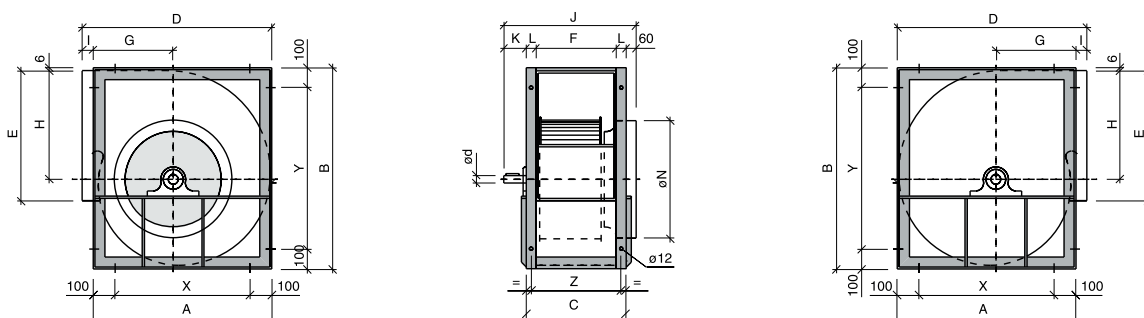

TAMAÑO	A	B	C	D	E	F	G	H	I	J	K	ød	L	øN	X	Y	Z
20 / 10	795	935	395	840	604	315	328	523	45	550	95	35	40	558	595	735	359
22 / 11	863	1019	430	908	695	350	354	571	45	583	95	35	40	628	663	819	392
25 / 13	953	1142	487	998	794	407	382	640	45	642	95	35	40	708	753	942	451
30 / 14	1159	1374	547	1204	933	467	472	778	45	734	130	40	40	798	959	1174	508

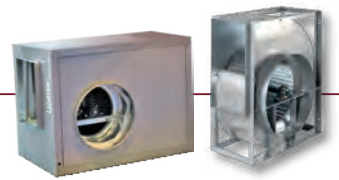

DIMENSIONES

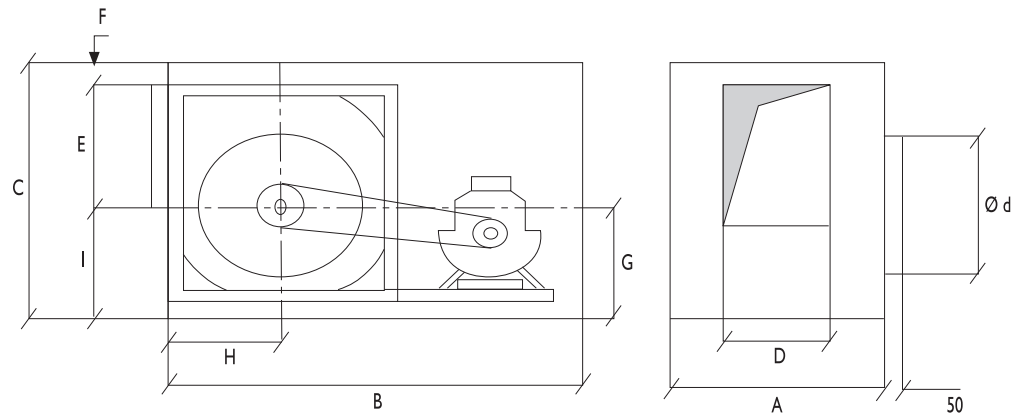

MODELO	MEDIDAS DE LAS CAJAS EN mm.									IMPULSIÓN VERTICAL		
	A	B	C	D	E	G	H	F	Ød	C ₁	B ₁	F ₁
CBT-SA 9/4	500	700	522	180	275	240	225	68	250			
CBT-SA 10/5	516	750	575	195	305	251	265	79	275			
CBT-SA 12/6	540	850	650	225	355	290	304	65	315			
CBT-SA 15/7	600	1000	755	280	415	325	335	84	400			
CBT-SA 18/9	620	1200	875	300	480	382	360	78	450			
CBT-SA 20/10	731	1301	1175	317	606	477	430	177	560	1080	1380	40
CBT-SA 22/11	763	1403	1250	350	694	515	450	165	630	1146	1510	40
CBT-SA 25/13	823	1503	1380	409	794	573	460	170	710	1226	1655	40
CBT-SA 30/14	857	1653	1600	466	934	702	570	121	800	1431	1875	40

ORIENTACIONES

Orientación (Vista lado transmisión)
 Orientation (View transmission side)

1
 Sentido horario
 (Rotación a la derecha)
 Clockwise
 (Right hand)
RD / OR.1

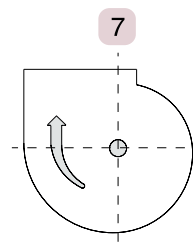
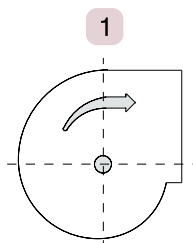

9
 Sentido anti horario
 (Rotación a izquierda)
 Counter clockwise
 (Left hand)
LG / OR.9

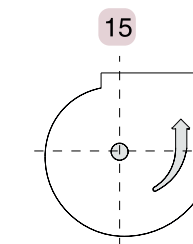
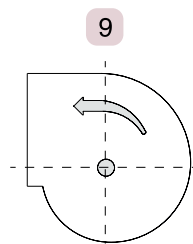

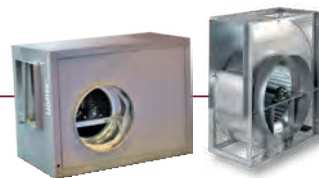

9/4

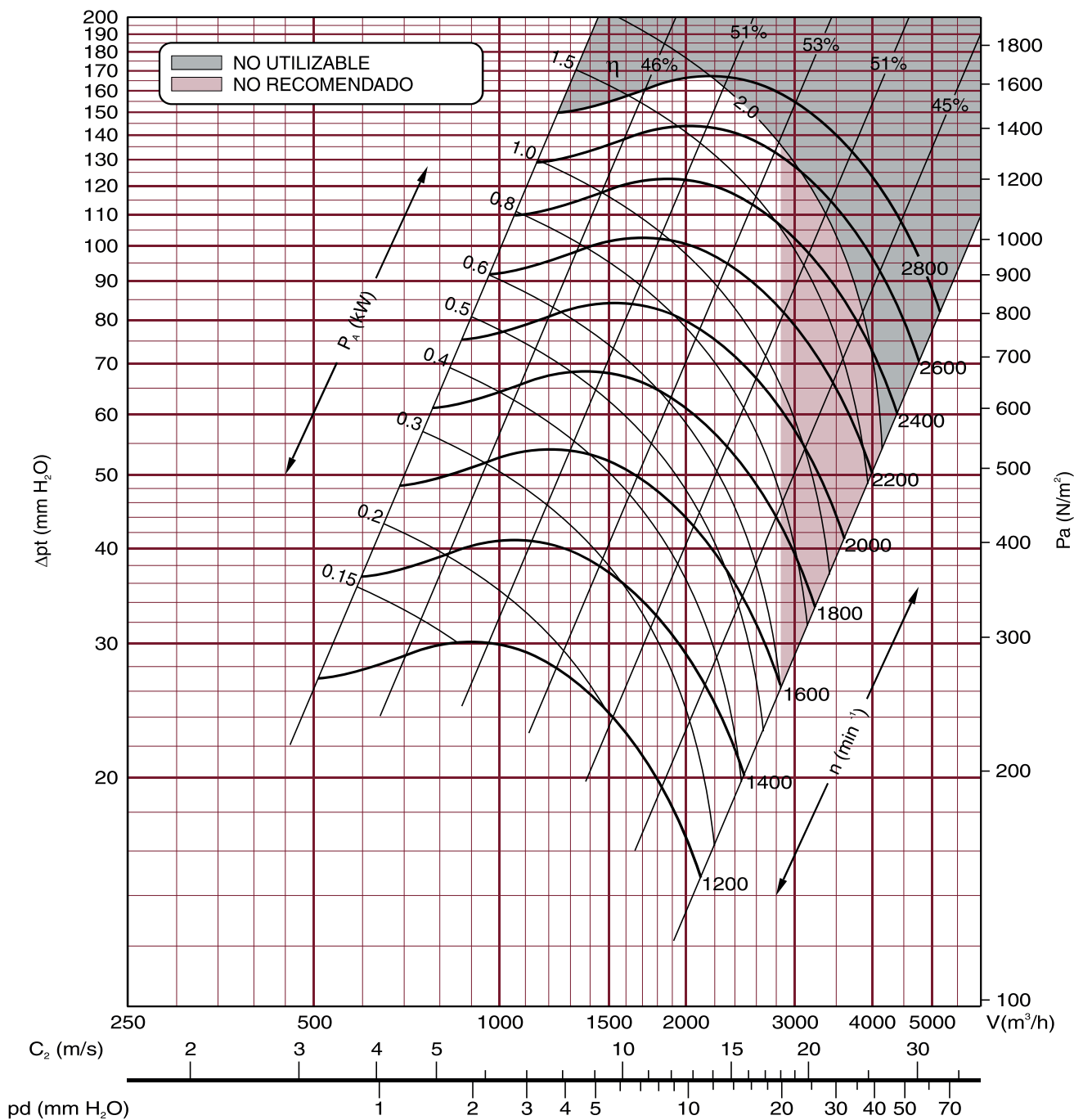

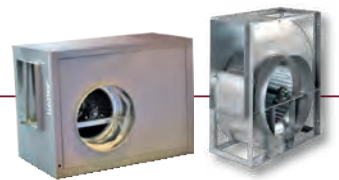

10/5

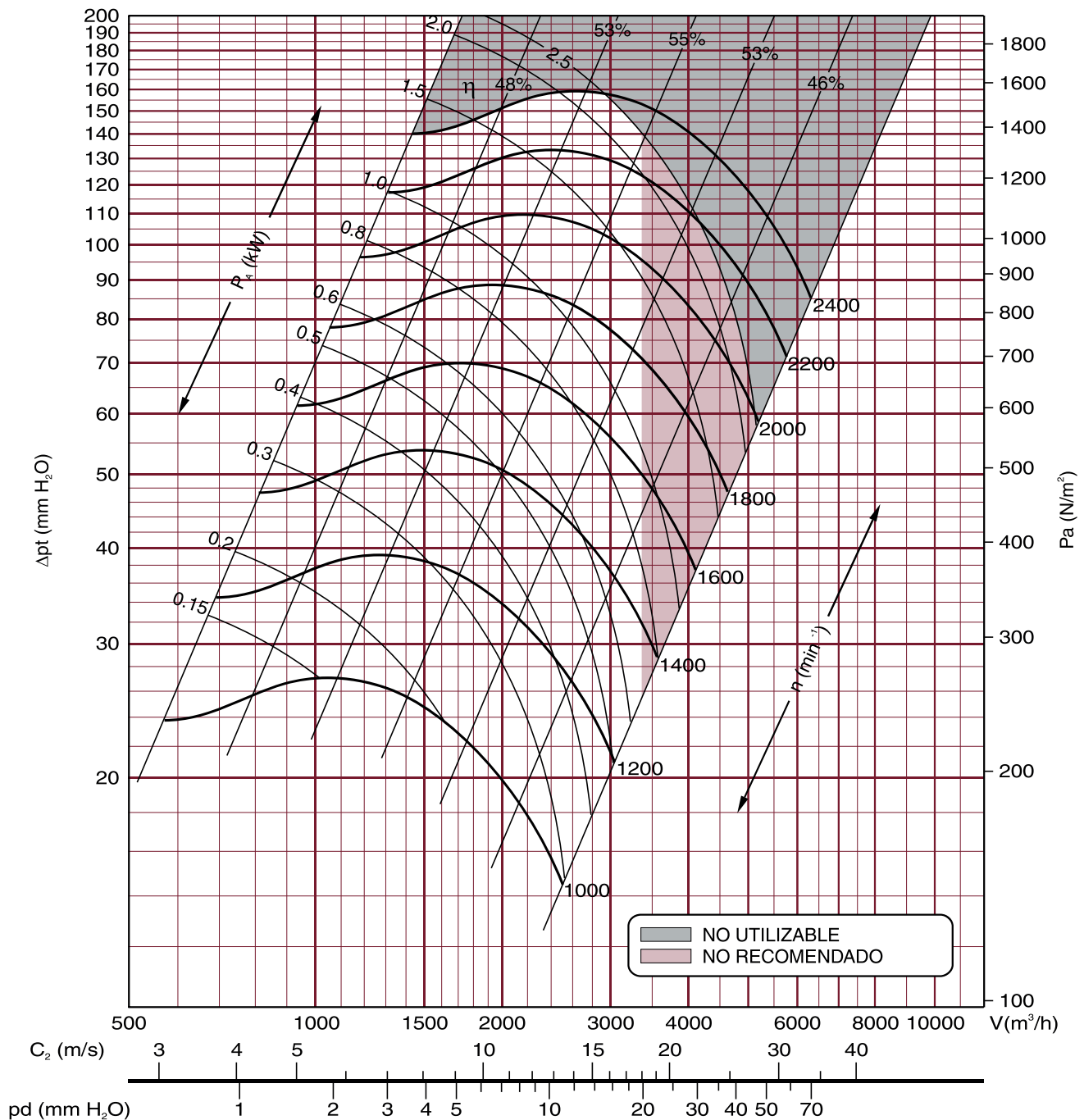

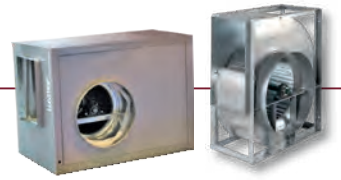

12/6

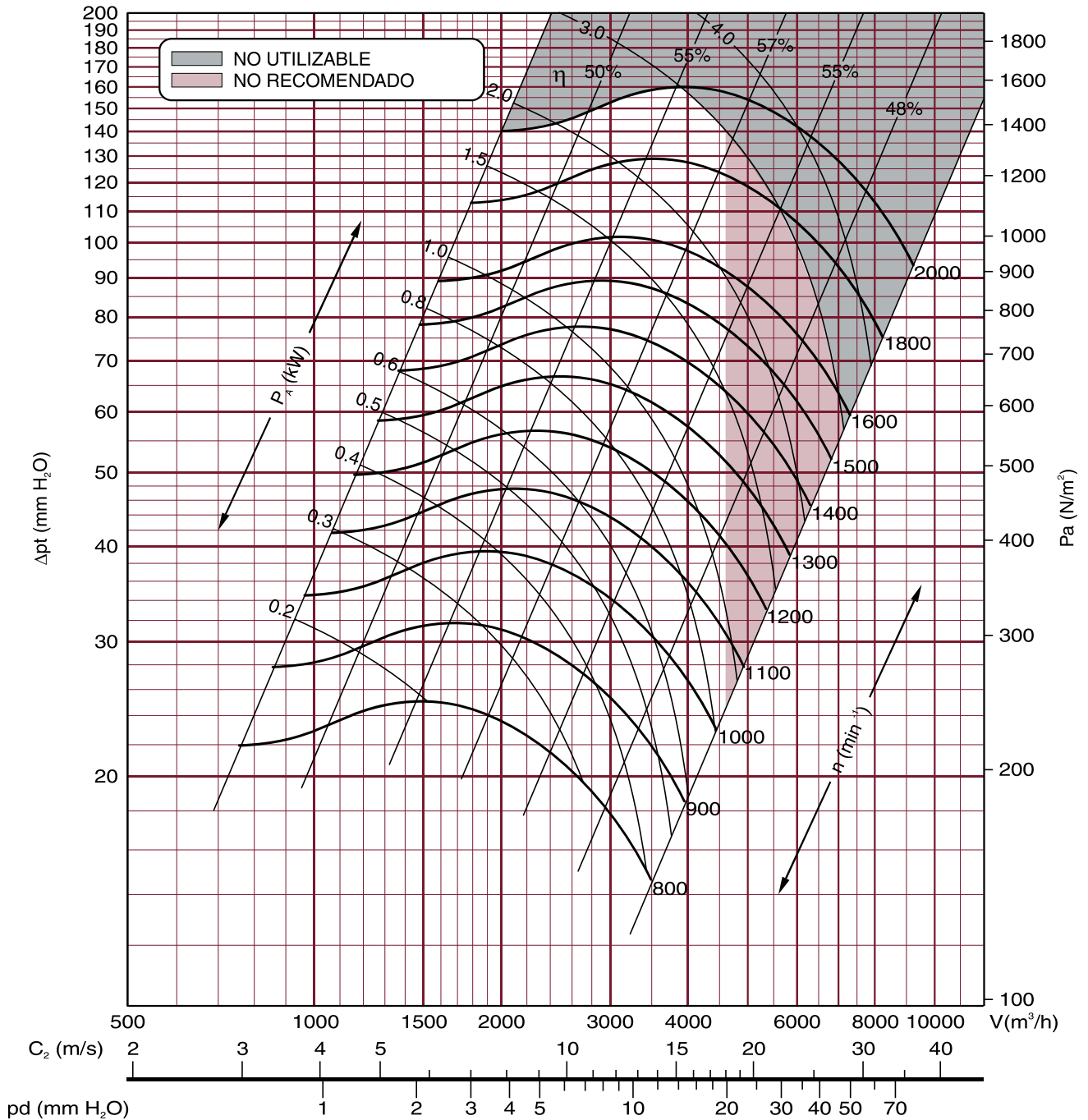

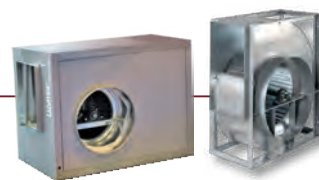

15/7

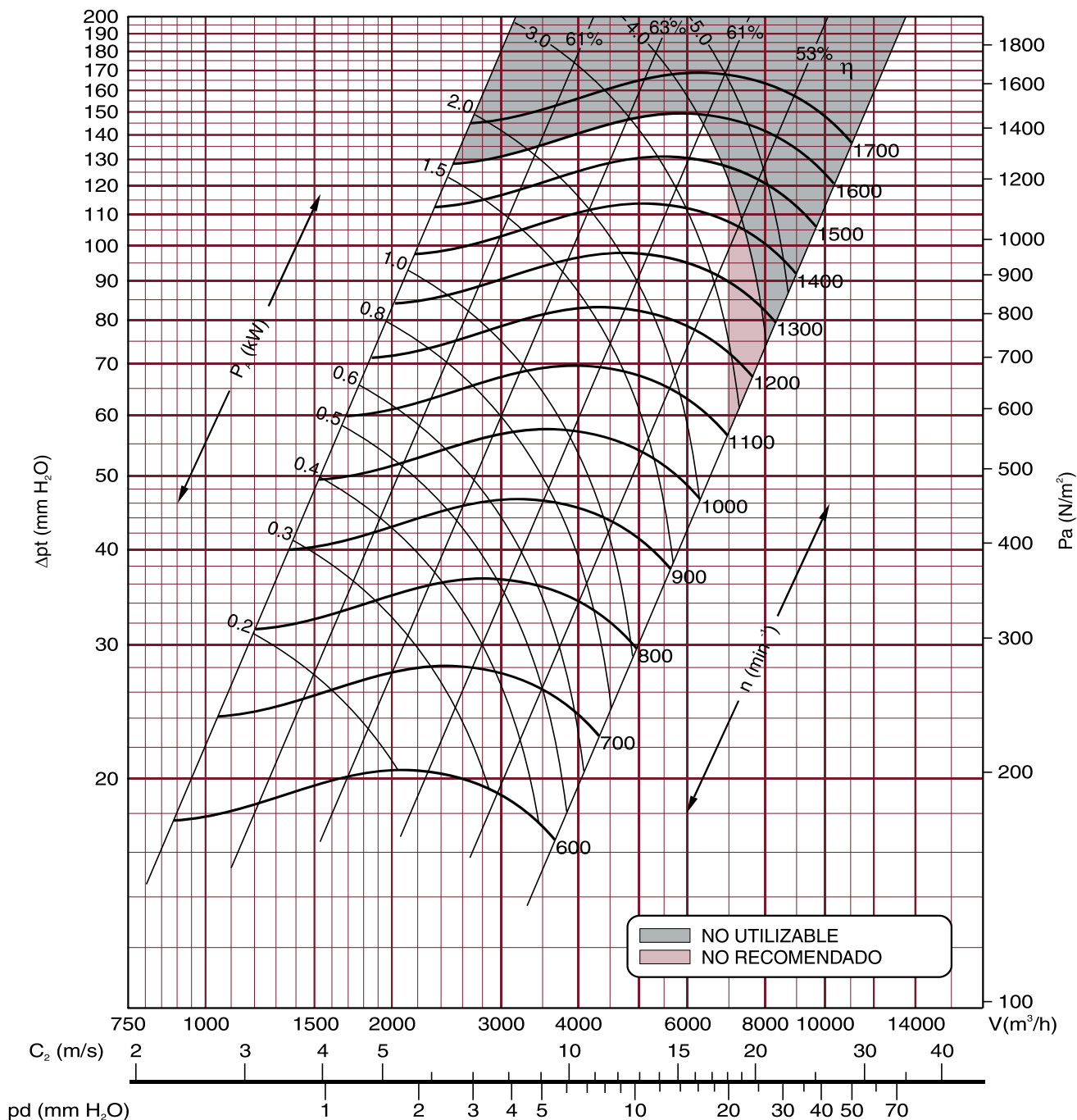

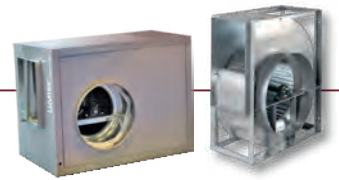

18/9

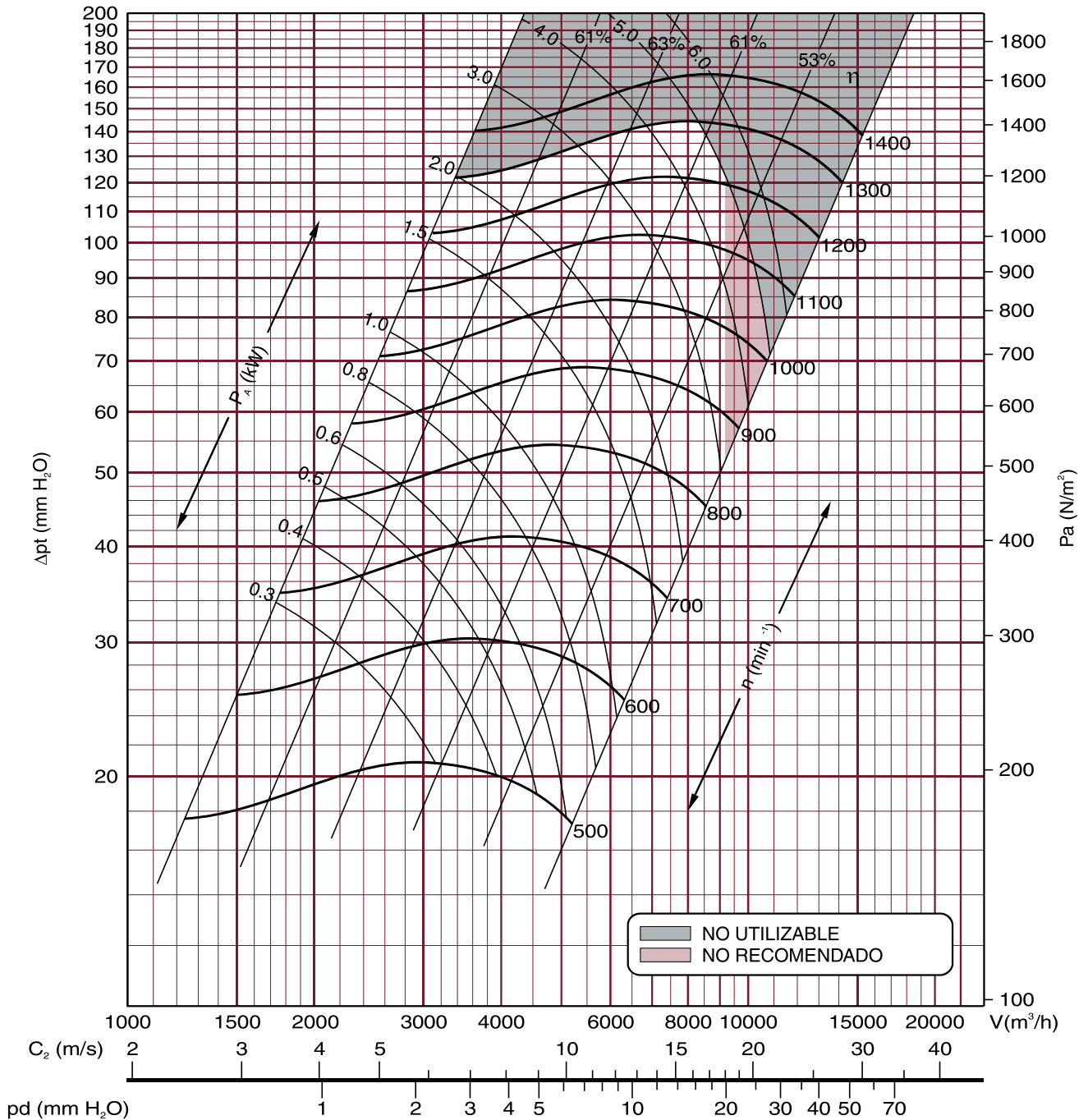

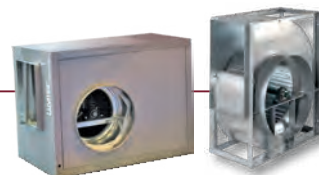

20/10

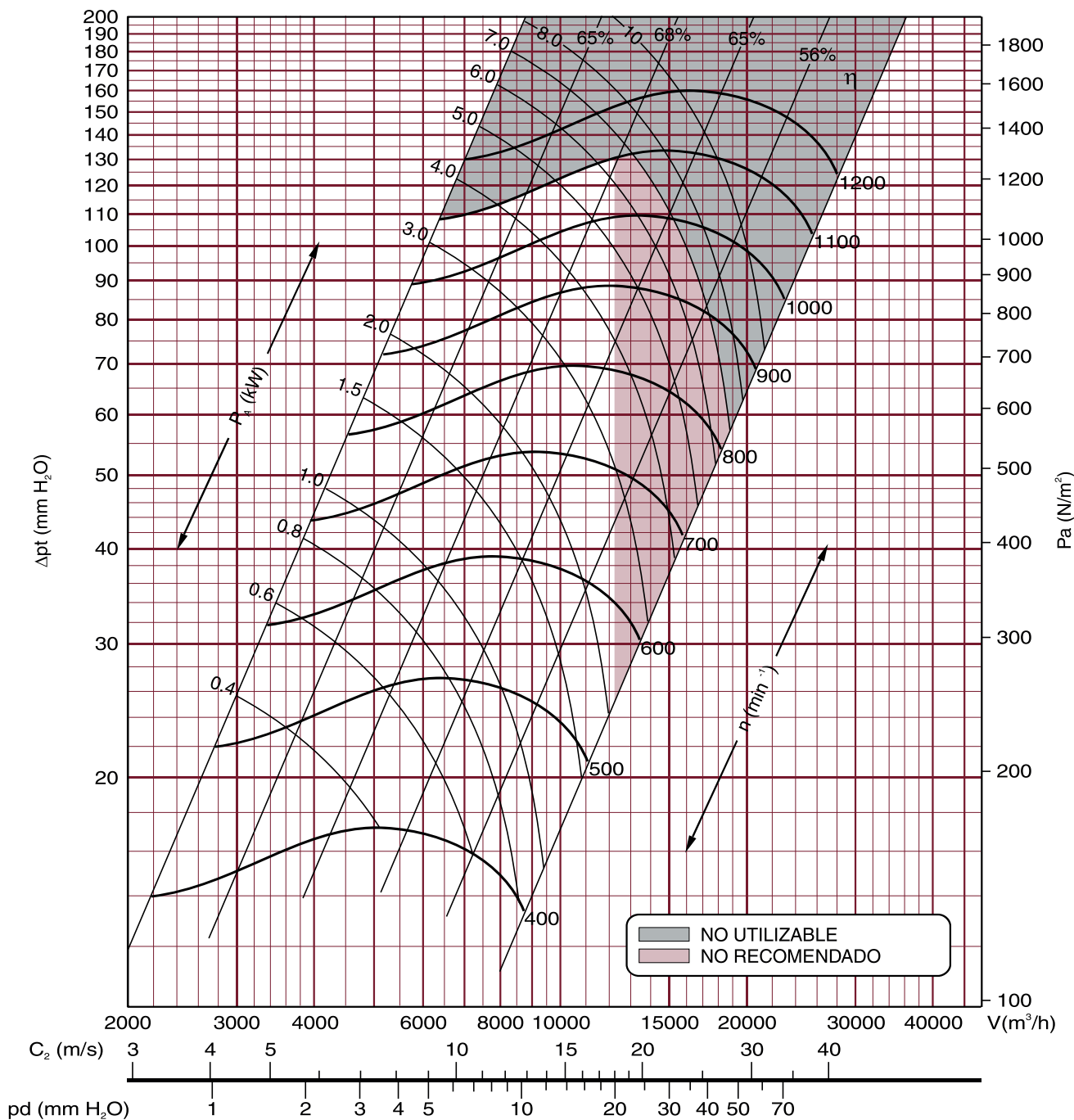

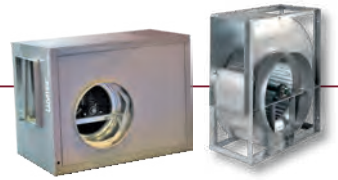

22/11

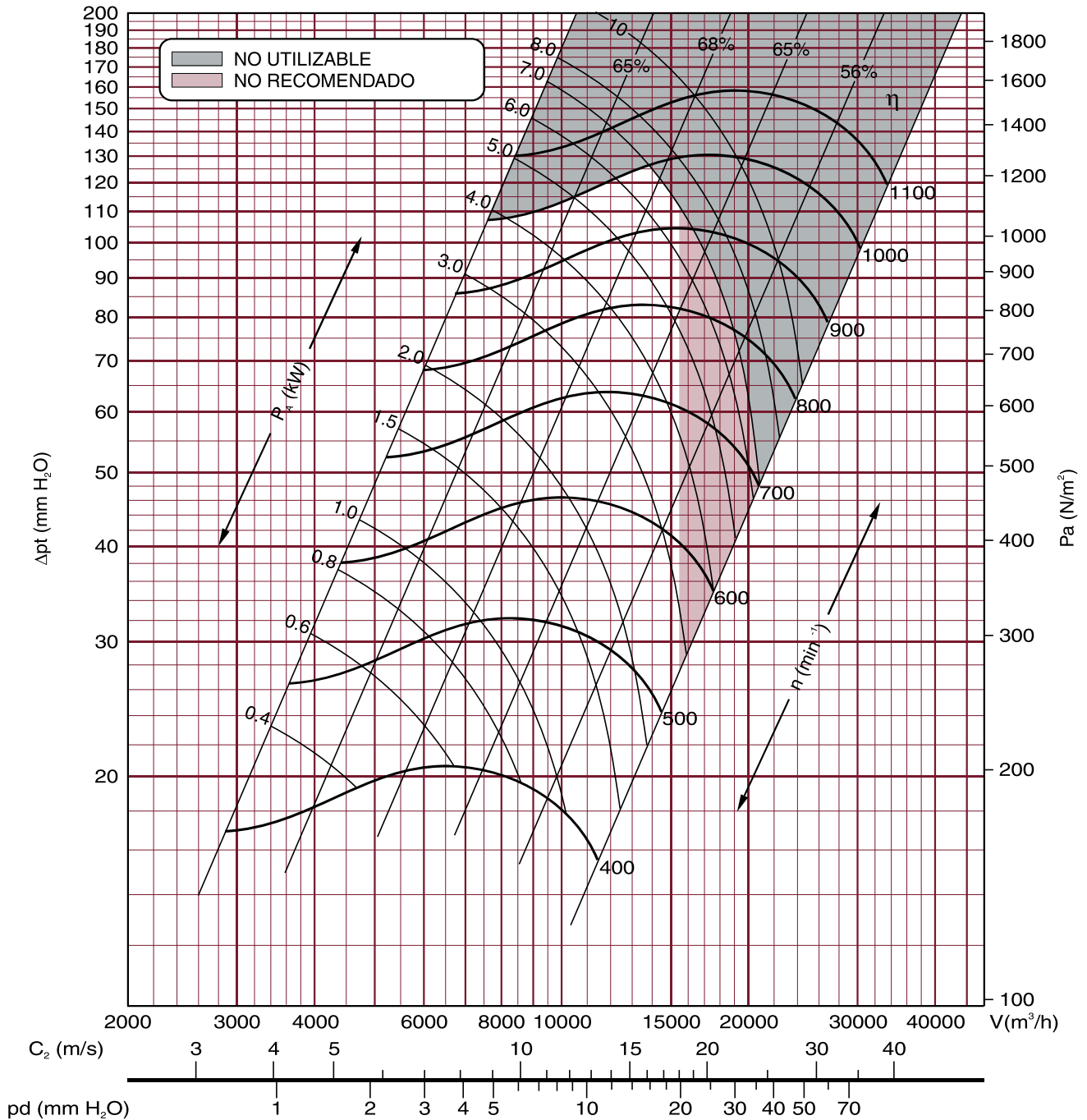

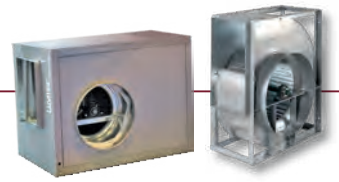

25/13

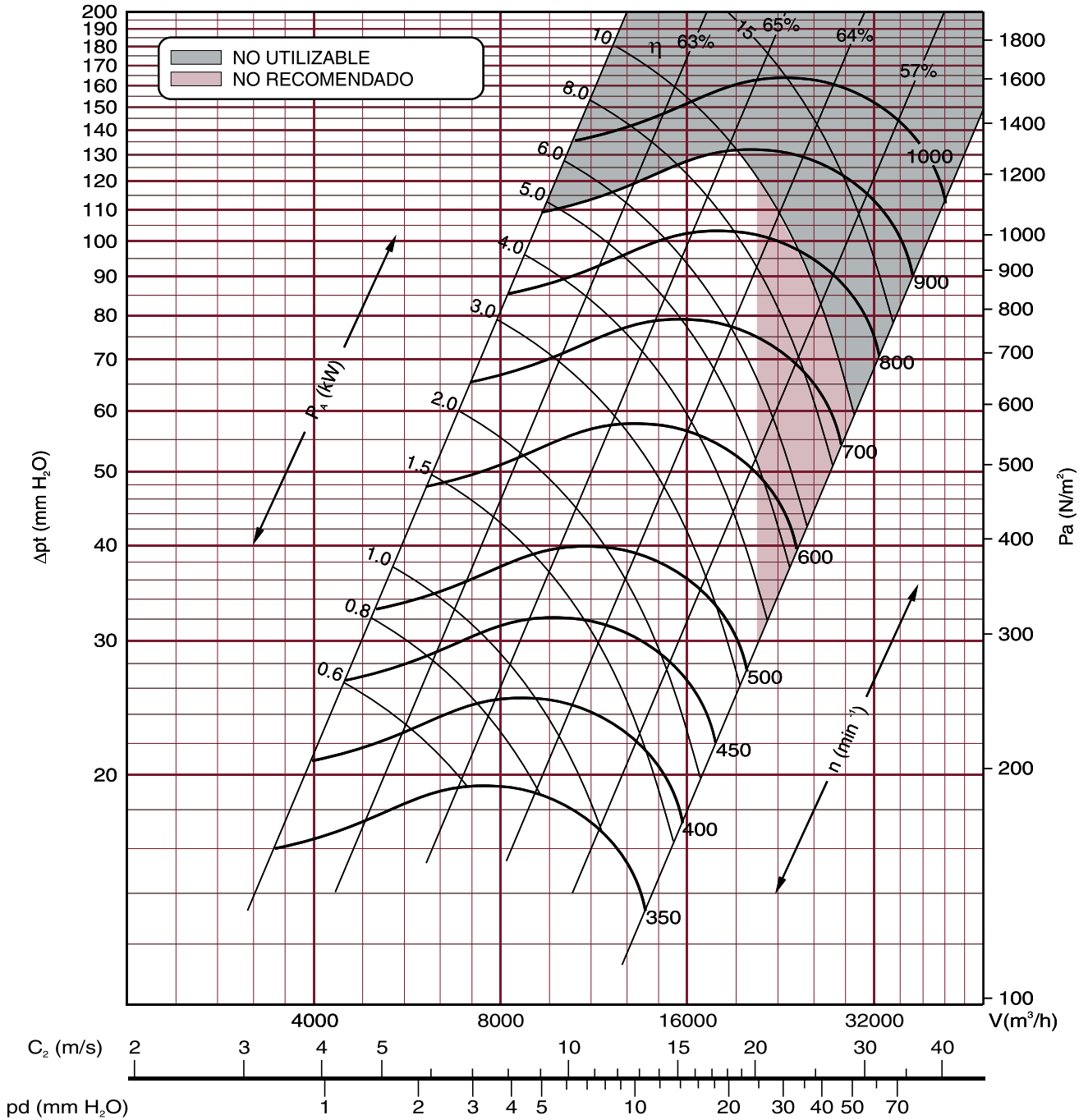

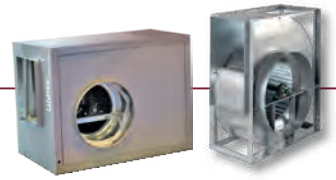

30/14

